

WS8-115 Winkelschleifer ME2

4935451292 - WS8-115 - 4000456052

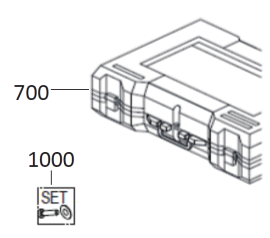
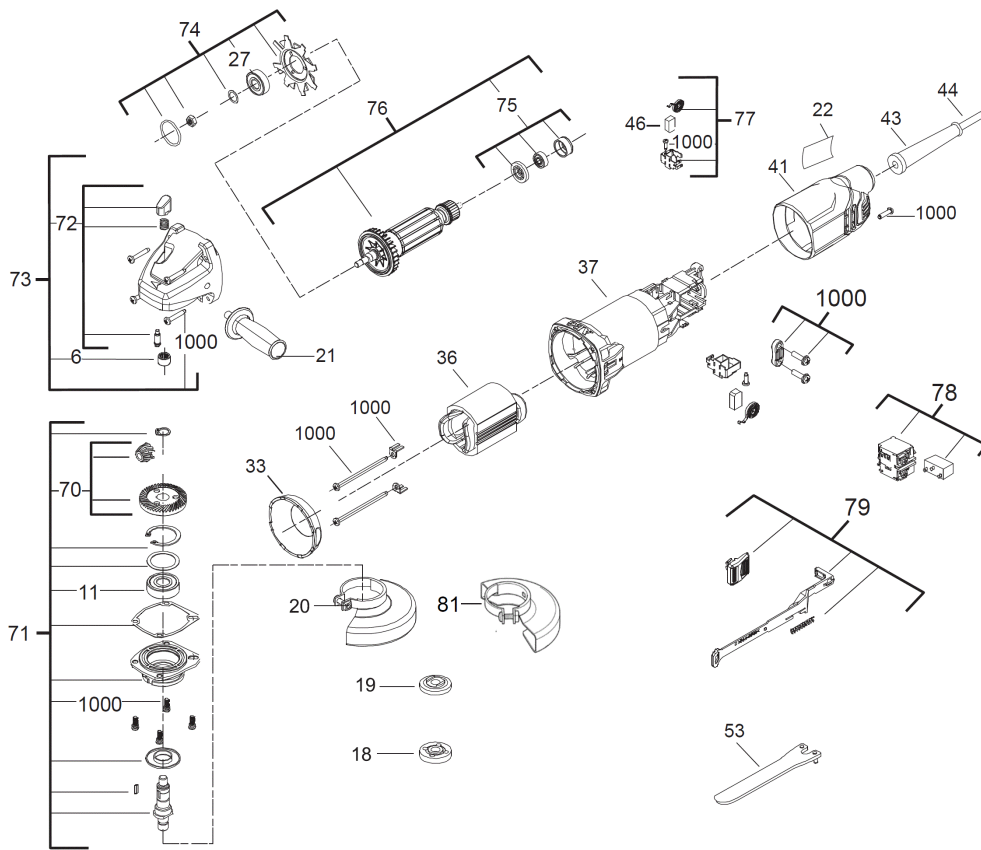

Position	Quantity	Description	Part number	EAN
0006 1	1	NADELLAGER	4931453616	4002395145904
0011 2	1	KUGELLAGER	4931453617	4002395145911
0018 3	1	FLANSCH	4931428704	4002395844210
0019 4	1	FLANSCH	4931453620	4002395145942
0020 5	1	SCHUTZHAUBE	4931453622	4002395145966
0021 6	1	HANDGRIFF KOMPL.	4931453624	4002395145980
0022 7	1	LEISTUNGSSCHILD	4931453626	4002395146604
0027 8	1	KUGELLAGER	4931453633	4002395146673
0033 9	1	LUFTFUEHRUNGSRING	4931453634	4002395146680
0036 10	1	FELD F. ELEKTROMOTOR	4931453635	4002395146697
0037 11	1	Motorgehaeuse	4931453636	4002395143900
0041 12	1	DECKEL	4931453637	4002395143917
0043 13	1	KABELSCHUTZSCHLAUCH	4931453638	4002395143924
0044 14	1	ELEKTRISCHES KABEL	4931453639	4002395143931
0046 15	2	KOHLEBUERSTE	4931453641	4002395143955
0053 16	1	MUTTERNDREHER	4931393248	4002395751051
0070 17	1	ANTRIEB	4931453642	4002395143962
0071 18	1	SPINDEL SATZ	4931453644	4002395143986
0072 19	1	ARRETIERBOLZEN	4931453645	4002395143993
0073 20	1	GETRIEBEKASTEN	4931453646	4002395144600
0074 21	1	LAGERSATZ	4931453647	4002395144617
0075 22	1	LAGER	4931453648	4002395144624
0076 23	1	ANKER F.ELEKTROMOTOR	4931453649	4002395144631
0077 24	2	BUERSTENHALTER	4931453650	4002395144648
0078 25	1	ELEKTRONIKSCHALTER	4931453651	4002395144655
0079 26	1	SCHALTHEBEL	4931453652	4002395144662
0081 27	1	TRENNSCHUTZHAUBE	4931453654	4002395144686
0700 28	1	TRANSPORTKOFFER	Item discontinued(4931413507)	
1000 29	1	SCHRAUBENSET	4931453656	4002395145300