

RLM36X41H50 36 V Akku-Rasenmaeher IN2

5133002807 - RLM36X41H50 - 4000462978





4000462978

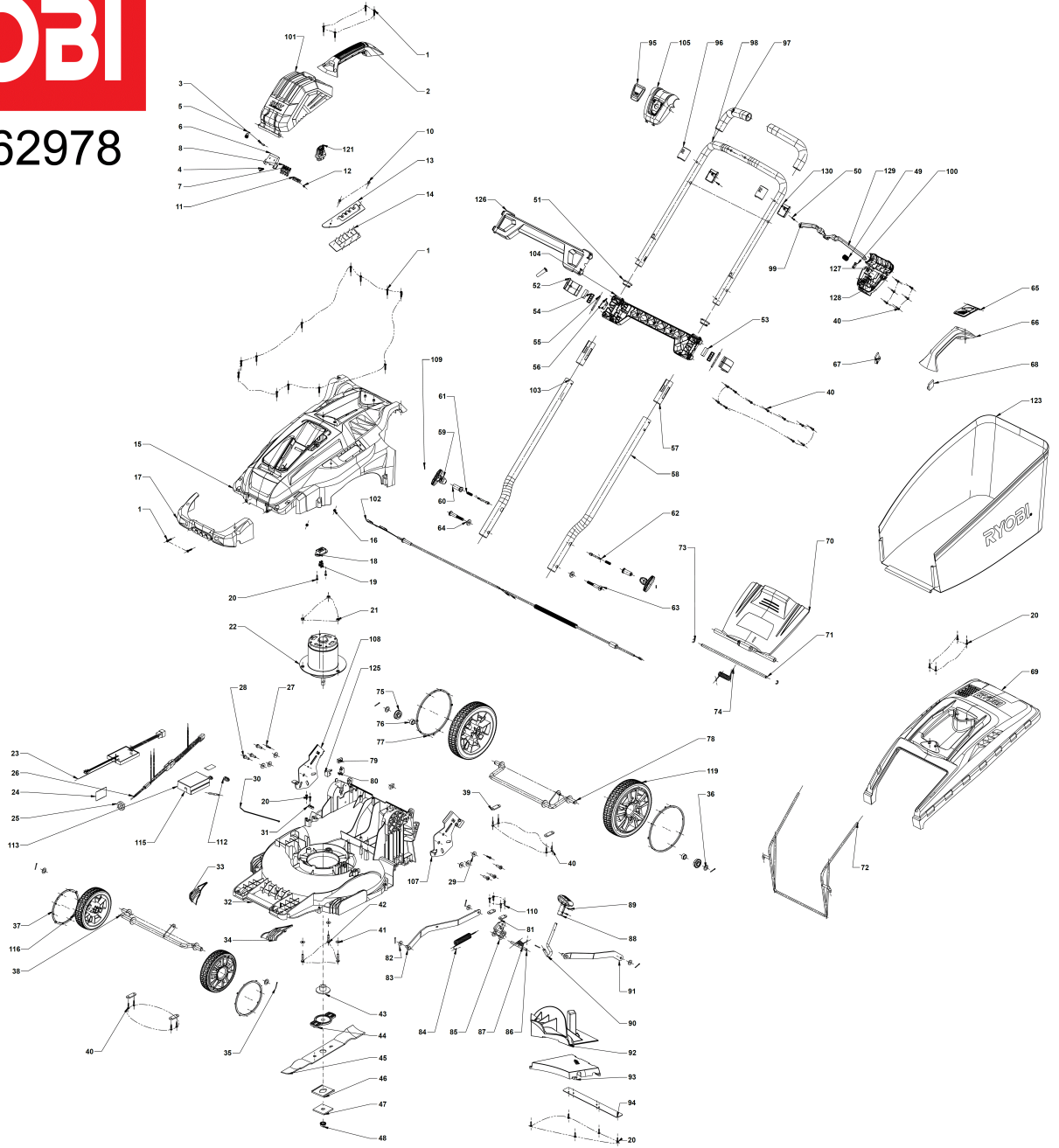

Position	Quantity	Description	Part number	EAN
1001 1	18	SCHRAUBE	5131035616	4058546150235
1002 2	1	HANDGRIFF	5131035617	4058546150242
1003 3	1	ACHSE	5131035622	4058546150297
1004 4	1	FEDER	5131035621	4058546150280
1005 5	1	FEDER	5131035620	4058546150273
1006 6	1	KONTAKT	5131035623	4058546150303
1007 7	1	KONTAKT	5131035625	4058546150327
1008 8	2	KONTAKT	5131035624	4058546150310
1011 9	1	VERBINDUNGSSTUECK	5131040186	4058546052485
1012 10	1	SCHRAUBE	5131035627	4058546150341
1013 11	1	ARRETIERBLECH	5131043740	4058546351007
1015 12	1	GEHAEUSE	5131040188	4058546052508
1016 13	2	MUTTER	5131011814	4058546098957
1018 14	1	TRAEGER	5131035636	4058546150426
1019 15	2	VERBINDUNGSLEITUNG	5131035637	4058546150433
1020 16	13	SCHRAUBE	5131044609	4058546383329
1021 17	3	MUTTER	5131035639	4058546150457
1022 18	1	MOTOR	5131035723	4058546151263
1023 19	1	ELEKTRONIK	5131043741	4058546351014
1024 20	1	ROHR	5131035745	4058546151478
1025 21	1	FERRITKERN	5131043742	4058546351021
1026 22	1	LEITUNG	5131043743	4058546351038
1027 23	2	SCHRAUBE	5131040190	4058546052522
1028 24	6	SCHRAUBE	5131040191	4058546052539
1029 25	6	SCHEIBE	5131040192	4058546052546
1031 26	1	FEDERKLEMME	5131035646	4058546150525
1032 27	1	GRUNDKOERPER	5131040194	4058546052560
1033 28	1	SEITENTEIL	5131043744	4058546351045
1034 29	1	DECKEL	5131035721	4058546151249
1035 30	8	STIFT	5131035642	4058546150488
1036 31	4	SCHEIBE	5131035654	4058546150594
1037 32	2	ABDECKUNG	5131040195	4058546052577
1038 33	1	ACHSE	5131035726	4058546151294
1039 34	4	KLEMMLEISTE	5131042942	4058546261566
1040 35	25	SCHRAUBE	5131035603	4058546150105
1041 36	3	SCHEIBE	5131035656	4058546150617
1042 37	3	SCHRAUBE	5131035657	4058546150624
1043 38	1	DISTANZSCHEIBE	5131042951	4058546261658
1044 39	1	HALTER	5131035659	4058546150648
1045 40	1	KLINGE	5132002438	4892210813497
1046 41	1	DISTANZSTUECK	5131035661	4058546150662
1047 42	1	HALTEPLATTE	5131035662	4058546150679
1048 43	1	MUTTER	5131035663	4058546150686
1049 44	1	FEDER	5131040206	4058546052683
1050 45	2	SCHRAUBE	5131040208	4058546052706
1051 46	2	DICHTBUECHSE	5131033530	4002395147724
1052 47	2	VERBINDUNGSSTUECK	5131033525	4002395147076
1053 48	2	GUMMIPLATTE	5131033528	4002395147700
1054 49	2	VERRIEGEL.-ELEMENT	5131033527	4002395147090
1055 50	2	STIFT	5131033526	4002395147083

Position	Quantity	Description	Part number	EAN
1056 51	1	SCHALTER	5131033532	4002395147748
1057 52	2	HUELSE	5131043064	4058546262785
1058 53	1	ROHR	5131040213	4058546052751
1059 54	2	DREHKNOPF	5131033551	4002395149131
1060 55	2	FEDER	5131033549	4002395149117
1061 56	2	FEDER	5131033550	4002395149124
1062 57	2	STIFT	5131040214	4058546052768
1063 58	2	SCHRAUBE	5131043745	4058546351052
1064 59	2	SCHEIBE	5131040216	4058546052782
1065 60	1	ANZEIGER	5131040217	4058546052799
1066 61	1	HANDGRIFF	5131035681	4058546150853
1067 62	1	STOPFEN	Item discontinued(5131040218)	
1068 63	1	STOPFEN	Item discontinued(5131040219)	
1069 64	1	DECKEL	5131035683	4058546150877
1070 65	1	TUER	5131035729	4058546151324
1071 66	1	ACHSE	5131035677	4058546150815
1072 67	1	GESTELL	5131035739	4058546151416
1073 68	2	FEDERKLEMME	5131035679	4058546150839
1074 69	1	FEDER	5131035678	4058546150822
1075 70	2	LAGER	5131035643	4058546150495
1076 71	2	DICHTBUECHSE	5131035644	4058546150501
1077 72	2	ABDECKUNG	5131040220	4058546052829
1078 73	1	ACHSE	5131035727	4058546151300
1079 74	2	MUTTER	5131040222	4058546052843
1080 75	1	KLEMME	5131040223	4058546052850
1081 76	2	ZWISCHENFLANSCH	5131041345	4058546066093
1082 77	3	SCHEIBE	5131035664	4058546056483
1083 78	1	PLEUEL	5131035730	4058546151331
1085 79	1	TRAEGER	5131035672	4058546150761
1088 80	1	HANDGRIFF	5131035671	4058546150754
1089 81	2	SCHRAUBE	5131035668	4058546150723
1090 82	1	ARM	5131035732	4058546151355
1091 83	1	ARM	5131035733	4058546151362
1092 84	1	STOPFEN	5131035738	4058546151409
1093 85	1	DECKEL	5131035722	4058546151256
1094 86	1	BLECH	5131035744	4058546151461
1095 87	1	DRUECKER	5131043060	4058546262747
1096 88	2	TRAEGER	5131040199	4058546052614
1097 89	2	MOOSGUMMI	5131040202	4058546052645
1098 90	1	GRIFF	5131040201	4058546052638
1099 91	1	DRUECKER	5131043062	4058546262761
1100 92	1	FEDER	5131036409	4058546157777
1101 93	1	Batterieabdeckung	5131043746	4058546351069
1102 94	1	KABEL	5131040210	4058546052720
1103 95	1	ROHR	5131040212	4058546052744
1104 96	1	ZWISCHENFLANSCH	5131040211	4058546052737
1105 97	1	DECKEL	5131043061	4058546262754
1107 98	1	SEITENTEIL	5131040224	4058546052867
1108 99	1	SEITENTEIL	5131040189	4058546052515
1109 100	2	FEDER	Item discontinued(5131017813)	

Position	Quantity	Description	Part number	EAN
1110 101	4	SCHRAUBE	5131041367	4058546066314
1112 102	1	GUMMIRING	5131043747	4058546351076
1113 103	1	DECKEL	5131043748	4058546351083
1115 104	1	GUMMIRING	5131043749	4058546351090
1116 105	2	RAD	5131040196	4058546052584
1119 106	2	RAD	5131040221	4058546052836
1121 107	1	SICHERUNGSSCHLUESSEL	5131035631	4058546150372
1123 108	1	Tasche, transparent	5131035740	4058546151423
1125 109	1	KLEMME	5131040193	4058546052553
1126 110	1	ZWISCHENFLANSCH	5131040209	4058546052713
1127 111	1	HALTER	5131041352	4058546066161
1128 112	1	GEHAEUSE UNTEN	5131043063	4058546262778
1129 113	1	DRUECKER	5131040203	4058546052652
1130 114	2	TRAEGER	5131040200	4058546052621