

BBH18CLI-202C AKKU-KOMBIHAMMER IN2

4935464985 - BBH18CLI-202C - 4000469651

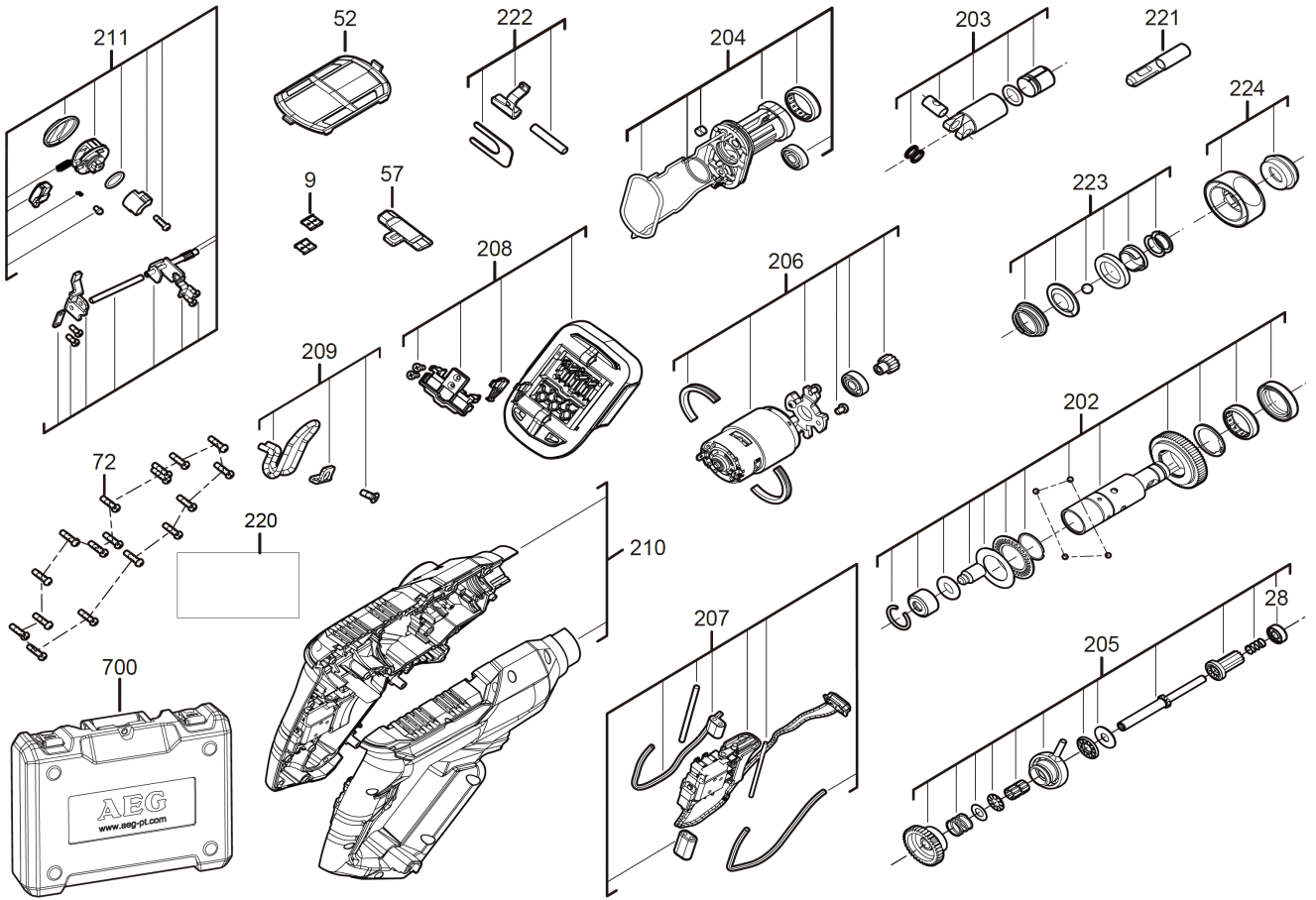



Position	Quantity	Description	Part number	EAN
0009 1	2	VERBINDUNGS-STUECK	631542001	4002395822591
0028 2	1	KUGELLAGER	4931472085	4058546283025
0052 3	1	STAUBFILTER	4931472086	4058546283032
0057 4	1	SCHIEBER	4931472087	4058546283049
0072 5	17	SCHRAUBE	4931461905	4058546230050
0202 6	1	SPINDEL	4931472088	4058546283056
0203 7	1	ZYLINDER	4931472089	4058546283063
0204 8	1	GETRIEBEKASTEN	4931472090	4058546283070
0205 9	1	SPINDEL SATZ	4931472091	4058546283087
0206 10	1	MOTOR	4931472092	4058546283094
0207 11	1	ELEKTRONIK	4931472093	4058546283100
0208 12	1	KONTAKTEINSATZ	4931472094	4058546283117
0209 13	1	HAKEN	4931472095	4058546283124
0210 14	1	GEHAEUSE	4931472096	4058546283131
0211 15	1	UMSCHALTER	4931472097	4058546283148
0220 16	1	LEISTUNGSSCHILD	4931472098	4058546283155
0221 17	1	ADAPTER	4931472099	4058546283162
0222 18	1	UMSCHALTER	4931472100	4058546283179
0223 19	1	BOHRFUTTER	4931472101	4058546283186
0224 20	1	KAPPE	4931472102	4058546283193
0700 21	1	TRANSPORTKASTEN	4931472103	4058546283209