

RIW18X-1X40SM AKKU-SCHLAGSCHRAUBER IN2

5133005943 - RIW18X-1X40SM - 4000475455

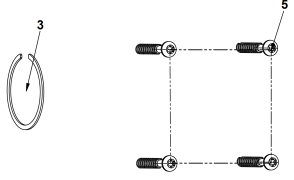

4000475455

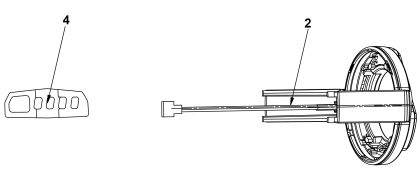
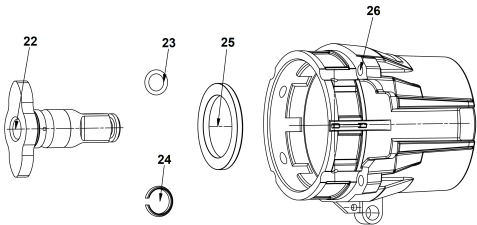
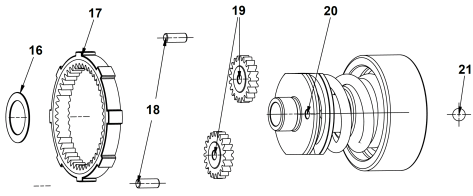
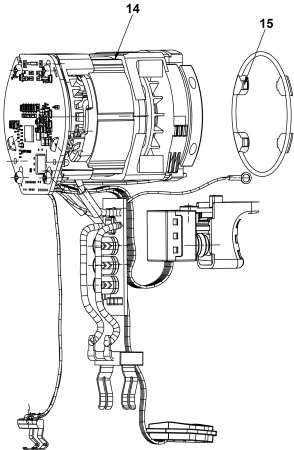
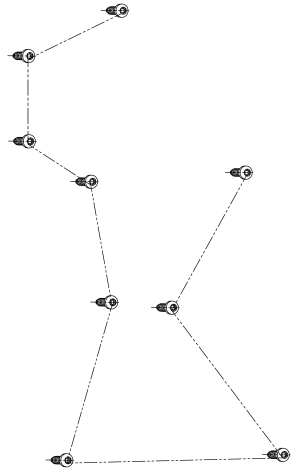
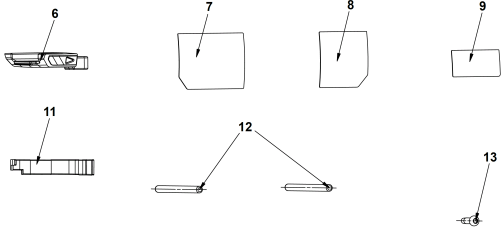
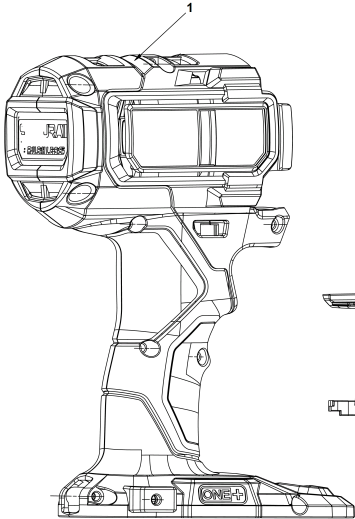

Position	Quantity	Description	Part number	EAN
1001 1	1	GEHAEUSE	5131044766	4058546384890
1002 2	1	LED LICHT	5131044767	4058546384906
1003 3	1	SICHERUNGSRING	5131044768	4058546384913
1004 4	1	ETIKETT	5131044764	4058546384876
1005 5	4	SCHRAUBE	5131044769	4058546384920
1006 6	1	DRUECKER	5131044770	4058546384937
1007 7	1	ETIKETT	5131044771	4058546384944
1008 8	1	ETIKETT	5131044772	4058546384951
1009 9	1	ETIKETT	5131044773	4058546384968
1011 10	1	VERBINDUNGSTEIL	5131044774	4058546384975
1012 11	2	STIFT	5131044775	4058546384982
1013 12	1	SCHRAUBE	5131044776	4058546384999
1014 13	1	DC-MOTOR	5131044777	4058546385002
1015 14	1	DICHTUNG	5131044778	4058546385019
1016 15	1	SCHEIBE	5131044779	4058546385026
1017 16	1	ZAHNRAD	5131044780	4058546385033
1018 17	2	STIFT	5131044781	4058546385040
1019 18	2	ZAHNRAD	5131044782	4058546385057
1020 19	1	SCHLAGKOERPER	5131044783	4058546385064
1021 20	1	KUGEL	5131046063	4058546456955
1022 21	1	NOCKENWELLE	5131044784	4058546385071
1023 22	1	O-RING	5131044785	4058546385088
1024 23	1	SICHERUNGSRING	4931416493	4002395898374
1025 24	1	SCHEIBE	5131044787	4058546385101
1026 25	1	GETRIEBEBECKEL	5131044788	4058546385118