

RPD18-2C20SA127 AKKU-SCHLAGBOHRER IN2

5133006961 - RPD18-2C20SA127 - 4000475767

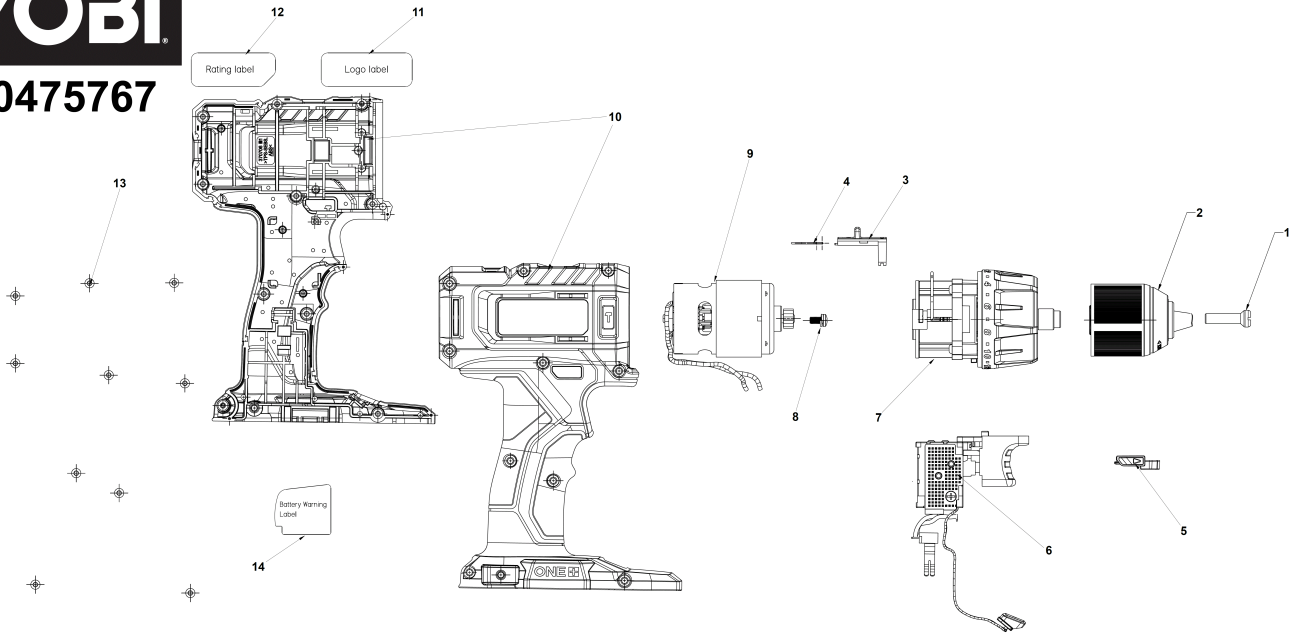

4000475767



Position	Quantity	Description	Part number	EAN
1001 1	1	SCHRAUBE	5131045380	4058546401146
1002 2	1	BOHRFUTTER	5131045382	4058546401177
1003 3	1	KNOPF	5131049627	4058546610302
1004 4	1	FEDER	5131049628	4058546610319
1005 5	1	KNOPF	5131049629	4058546610326
1006 6	1	SCHALTER	5131049630	4058546610333
1007 7	1	GETRIEBEKASTEN	5131049631	4058546610340
1008 8	2	SCHRAUBE	5131033433	4002395161102
1009 9	1	DC-MOTOR	5131049632	4058546610357
1010 10	1	GEHAEUSE	5131049633	4058546610364
1011 11	1	ETIKETT	5131045312	4058546399771
1012 12	1	LEISTUNGSSCHILD	5131049634	4058546610371
1013 13	10	SCHRAUBE	5131048467	4058546545963