

RPD18C1-2C20SA32 AKKU-SCHLAGBOHRER IN2

5133006793 - RPD18C1-2C20SA32 - 4000486659

RYOBI

4000486659

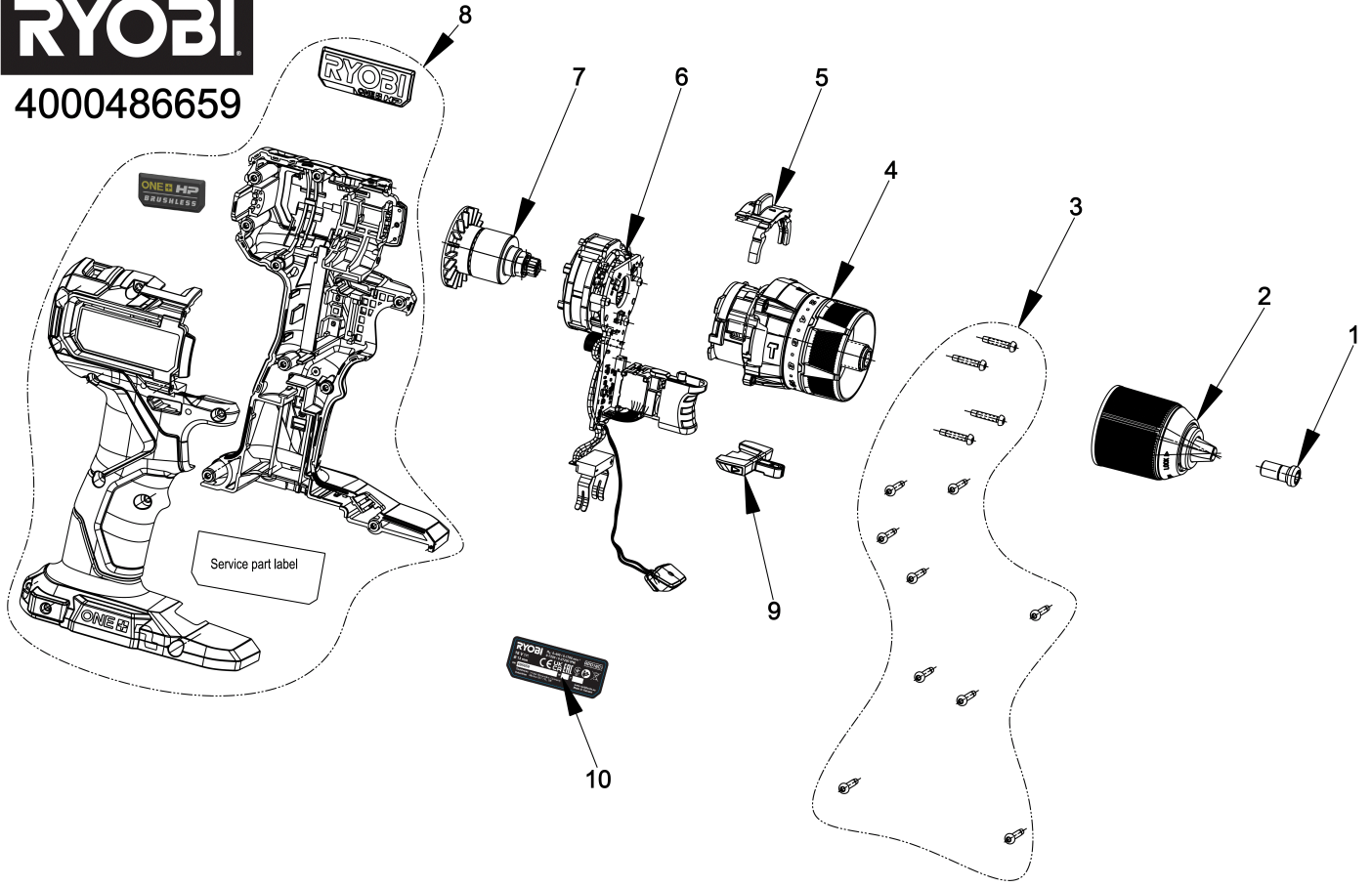

Position	Quantity	Description	Part number	EAN
1001 1	1	SCHRAUBE	5131045028	4058546399498
1002 2	1	BOHRFUTTER	5131048466	4058546545956
1003 3	13	SCHRAUBE	5131048467	4058546545963
1004 4	1	GETRIEBE	5131048472	4058546546014
1005 5	1	KNOPF, KUNSTSTOFF F. AKKU-SCHRAUBER	5131048469	4058546545987
1006 6	1	PART NOT DETAILED	1000063920	
1007 7	1	PART NOT DETAILED	1000063920	
1008 8	1	GEHAEUSE	5131048473	4058546546021
1009 9	1	WECHSELKNOPF	5131043949	4058546378851
1010 10	1	LEISTUNGSSCHILD	5131048474	4058546546038