

WS12-125S Winkelschleifer IN2

4935451306 - WS12-125S - 4000504124

AEG 4000504124
4000504128
4000504376

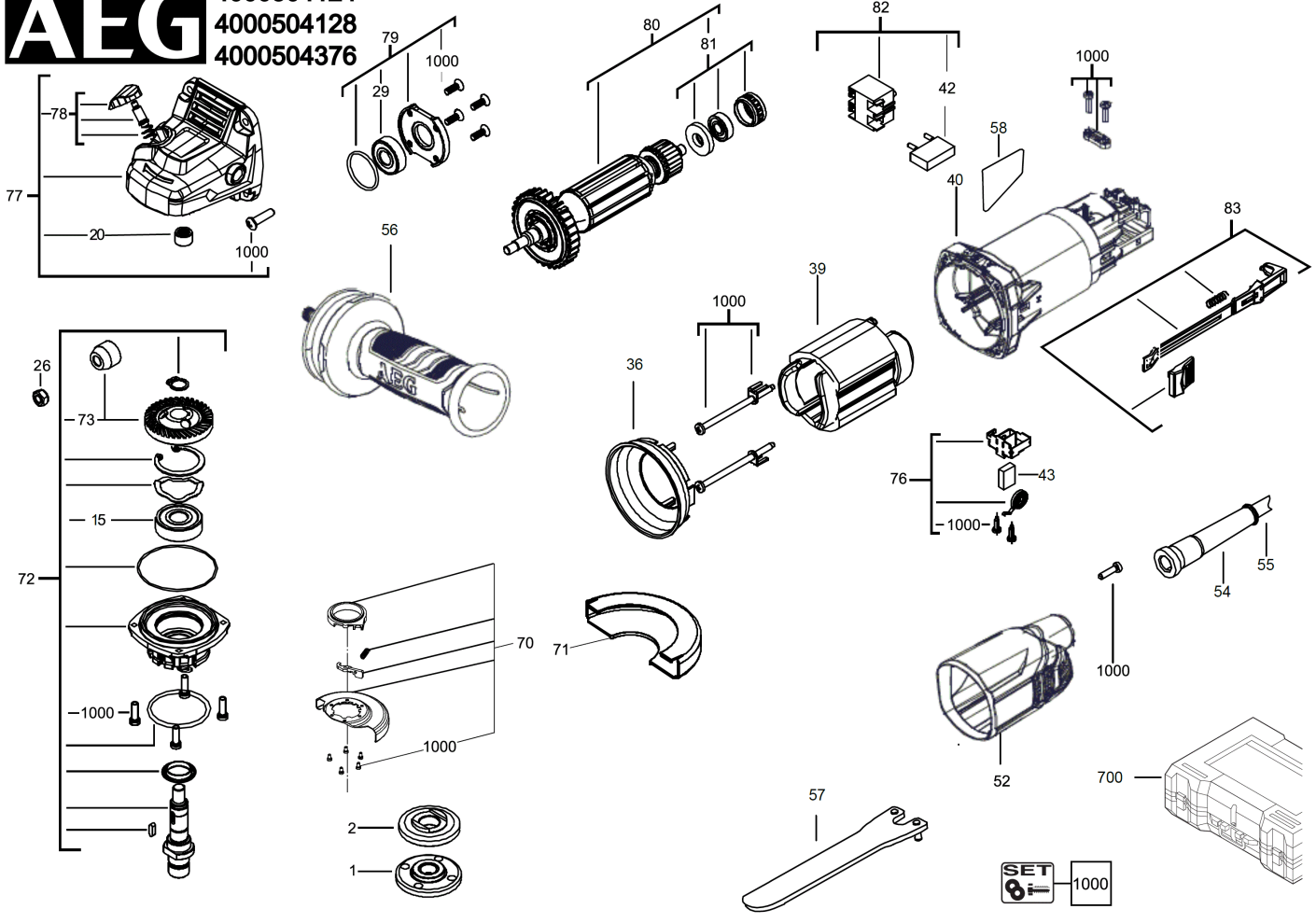

Position	Quantity	Description	Part number	EAN
0001 1	1	SPANNFLANSCH	4931508071	4058546627331
0002 2	1	FLANSCH	4931453620	4002395145942
0015 3	1	KUGELLAGER	4931453697	4002395146130
0020 4	1	NADELLAGER	4931453616	4002395145904
0026 5	1	MUTTER	4931428715	4002395844364
0029 6	1	KUGELLAGER	4931453633	4002395146673
0036 7	1	LUFTFUEHRUNGSRING	4931428721	4002395844425
0039 8	1	FELD F. ELEKTROMOTOR	4931428724	4002395844456
0040 9	1	MOTORGEHAEUSE	4931453698	4002395146147
0042 10	1	KONDENSATOR	4931428728	4002395844494
0043 11	2	KOHLEBUERSTE	4931428732	4002395844531
0052 12	1	ABDECKKAPPE	4931453699	4002395146154
0054 13	1	KABELSCHUTZSCHLAUCH	4931428735	4002395844562
0055 14	1	ANSCHLUSSLEITUNG	4931428736	4002395844579
0056 15	1	HANDGRIFF	4931428739	4002395844609
0057 16	1	MUTTERNDREHER	4931508074	4058546627362
0058 17	1	LEISTUNGSSCHILD	Item discontinued(4931508092)	
0070 18	1	SCHUTZHAUBE	4931508081	4058546627430
0071 19	1	TRENNSCHUTZHAUBE	4931508075	4058546627379
0072 20	1	SPINDEL SATZ	4931508083	4058546627454
0073 21	1	ANTRIEB	4931508084	4058546627461
0076 22	2	BUERSTENHALTER	4931508085	4058546627478
0077 23	1	GETRIEBEKASTEN	4931508086	4058546627485
0078 24	1	ARRETIERBOLZEN	4931508087	4058546627492
0079 25	1	LAGERSATZ	4931508088	4058546627508
0080 26	1	ANKER F.ELEKTROMOTOR	4931508094	4058546627560
0081 27	1	LAGER	4931508089	4058546627515
0082 28	1	ELEKTRONIKSCHALTER	4931453713	4002395146895
0083 29	1	SCHALTHEBEL	4931453708	4002395146840
0700 30	1	TRANSPORTKASTEN	4931453709	4002395146857
1000 31	1	SCHRAUBENSET	4931508095	4058546627577