

# RY36LMX51A-160 AKKU-RASENMAEHER IN2

5133004589 - RY36LMX51A-160 - 4000504302



# RYOBI

## 4000504302

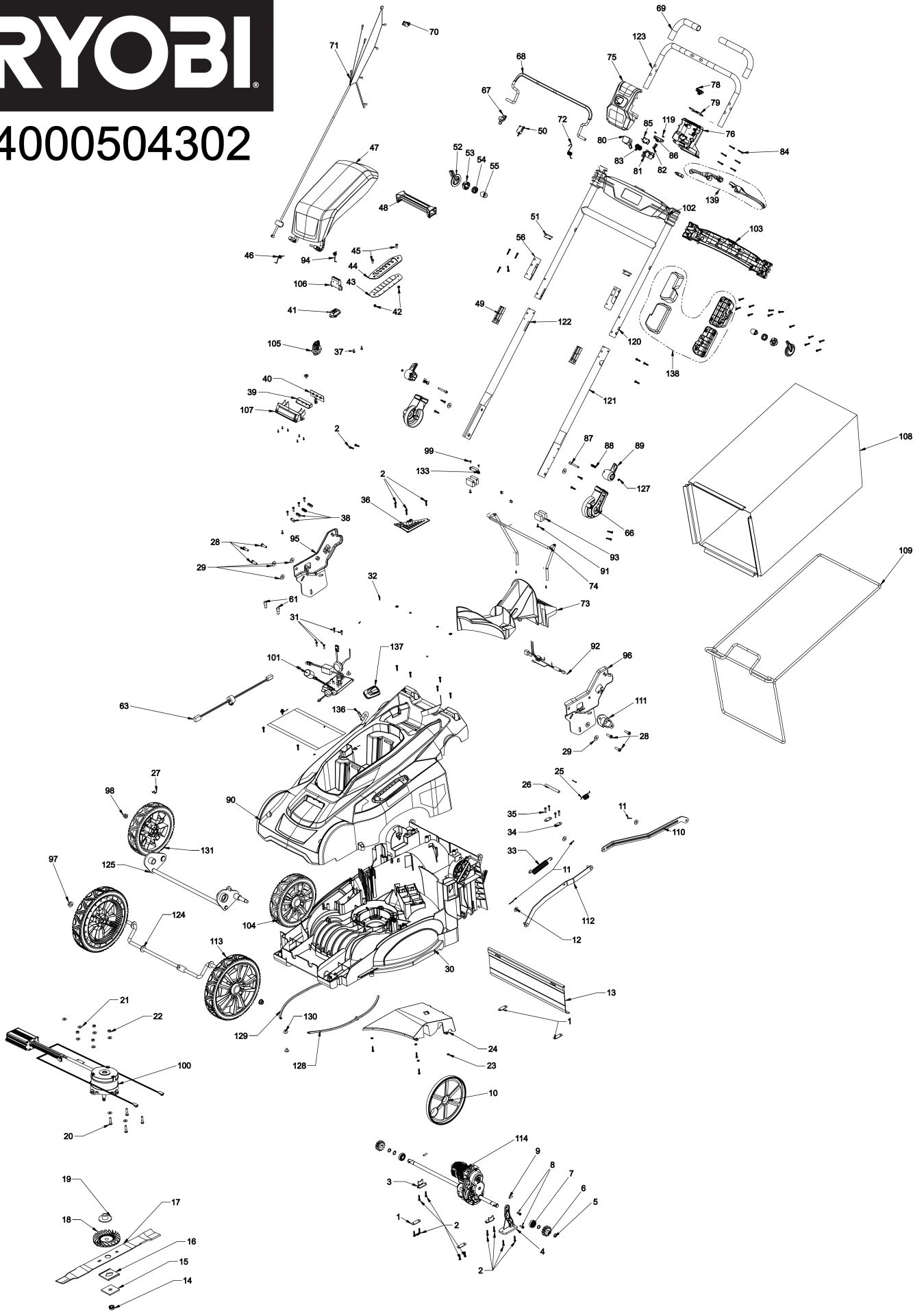

Position	Quantity	Description	Part number	EAN
1001 1	4	KLEMMLEISTE	5131042942	4058546261566
1002 2	45	SCHRAUBE	5131035616	4058546150235
1003 3	2	HALTERUNG	5131042943	4058546261573
1004 4	1	BEFESTIGUNGSTEIL	5131042944	4058546261580
1005 5	4	Sicherungsring	5131001913	4058546162429
1006 6	2	ZAHNRAD	5131042945	4058546261597
1007 7	2	LAGER	5131040854	4058546061180
1008 8	2	SCHRAUBE	5131041891	4058546251055
1009 9	2	STIFT	5131042946	4058546261603
1010 10	2	ABDECKUNG	5131042947	4058546261610
1011 11	4	STIFT	5131035642	4058546150488
1012 12	3	SCHEIBE	5131035664	4058546056483
1013 13	1	SCHUTZ	5131042948	4058546261627
1014 14	1	MUTTER	5131035663	4058546150686
1015 15	1	HALTEPLATTE	5131035662	4058546150679
1016 16	1	DISTANZSCHEIBE	5131042949	4058546261634
1018 17	1	LUEFTER	5131043039	4058546262532
1019 18	1	DISTANZSCHEIBE	5131042951	4058546261658
1020 19	4	SCHRAUBE	5131035657	4058546150624
1021 20	8	SCHEIBE	5131035656	4058546150617
1022 21	4	MUTTER	5131035639	4058546150457
1023 22	4	SCHEIBE	Item discontinued(5131033446)	
1024 23	1	ABDECKUNG	5131042952	4058546261665
1025 24	1	FEDER	5131044807	4058546458164
1026 25	1	ACHSE	5131044808	4058546458157
1027 26	4	SCHRAUBE	5131035668	4058546150723
1028 27	6	SCHRAUBE	5131033516	4002395164387
1029 28	8	SCHEIBE	5131040192	4058546052546
1030 29	1	GRUNDKOERPER	5131049189	4058546605926
1031 30	8	SCHRAUBE	5131044609	4058546383329
1032 31	1	SCHRAUBE	5131035887	4058546152765
1033 32	1	FEDER	5131049190	4058546605933
1034 33	2	ZWISCHENFLANSCH	5131041345	4058546066093
1035 34	4	SCHRAUBE	5131035603	4058546150105
1036 35	1	DECKEL	5131049191	4058546605940
1037 36	3	SCHRAUBE	5131036253	4058546156244
1038 37	3	FEDERKLEMME	5131035646	4058546150525
1040 38	1	ELEKTRONIK	5131042957	4058546261719
1041 39	1	TRAEGER	5131035636	4058546150426
1042 40	2	MUTTER	5131011814	4058546098957
1043 41	1	GUMMIPLATTE	5131042958	4058546261726
1044 42	1	EINSTELLVORRICHTUNG	5131042959	4058546261733
1045 43	2	SCHRAUBE	5131035632	4058546150389
1046 44	1	FEDER	5131042960	4058546261740
1047 45	1	DECKEL	5131042961	4058546261757
1048 46	1	HALTEGRIFF	5131042962	4058546261764
1049 47	1	STOPFEN	5131042963	4058546261771
1050 48	1	SCHALTER	5131033532	4002395147748
1051 49	2	DICHTBUECHSE	5131033530	4002395147724
1052 50	2	RIEGEL	5131042964	4058546261788

Position	Quantity	Description	Part number	EAN
1053 51	2	RIEGEL	5131045395	4058546401504
1054 52	2	FEDER	5131042966	4058546261801
1055 53	2	GUMMISCHEIBE	5131042967	4058546261818
1056 54	2	HUELSE	5131042968	4058546261825
1061 55	2	ANSCHLUSS	5131040277	4058546053390
1063 56	1	LEITUNG	5131042970	4058546261849
1066 57	2	GELENKSTUECK	5131042974	4058546261887
1067 58	1	SCHALTHEBEL	5131042975	4058546261894
1068 59	1	BETAETIGUNGSHEBEL	5131042976	4058546261900
1069 60	2	SCHAUMSTOFF	5131049192	4058546605957
1070 61	2	SCHALTER	5131042979	4058546261931
1071 62	2	KABELBAUM	5131042980	4058546261948
1072 63	1	FEDER	5131042982	4058546261962
1073 64	1	MULCHADAPTER	5131049193	4058546605964
1074 65	1	GESTELL	5131042985	4058546261993
1075 66	1	GEHAEUSEDECKEL	5131042986	4058546262006
1076 67	1	GEHAEUSE	5131042987	4058546262013
1078 68	1	DRUECKER	5131042988	4058546262020
1079 69	1	SCHIEBER	5131042989	4058546262037
1080 70	1	MITNEHMER	5131042990	4058546262044
1081 71	1	KNOPF	5131042991	4058546262051
1082 72	1	FEDER	5131036409	4058546157777
1083 73	1	FEDER	5131042993	4058546262075
1084 74	6	SCHRAUBE	5131034780	4058546143510
1085 75	2	SCHALTER	5131033535	4002395147779
1086 76	1	SCHALTER	5131042994	4058546262082
1087 77	2	STIFT	5131049195	4058546605988
1088 78	2	FEDER	5131049196	4058546605995
1089 79	2	DREHKNOPF	5131045446	4058546430382
1090 80	1	GEHAEUSE	5131042998	4058546262129
1091 81	2	SCHRAUBE	5131044653	4058546383763
1092 82	1	LEITUNG	5131042999	4058546262136
1093 83	2	MAGNETSCHALTER	5131045459	4058546430511
1094 84	1	FEDER	5131043001	4058546262150
1095 85	1	RECHTER HALTEBUEGEL	5131043002	4058546262167
1096 86	1	LINKER HALTEBUEGEL	5131043003	4058546262174
1097 87	2	MUTTER	5131033513	4002395164356
1098 88	2	MUTTER	5131033521	4002395147038
1100 89	1	MOTOR	5131043006	4058546262204
1101 90	1	ELEKTRONIK	5131043007	4058546262211
1102 91	1	GRIFF LINKS	5131043008	4058546262228
1103 92	1	GRIFF RECHTS	5131043009	4058546262235
1104 93	2	RAD	5131043010	4058546262242
1105 94	1	SICHERUNGSSCHLUESSEL	5131035631	4058546150372
1106 95	1	AUFNAHMESCHAFT	5131043011	4058546262259
1107 96	1	ABDECKUNG	5131043012	4058546262266
1108 97	1	GRASFANGSACK	5131049197	4058546606008
1109 98	1	GESTELL	5131043014	4058546262280
1110 99	1	HALTEBUEGEL	5131043015	4058546262297
1111 100	1	TRAEGER	5131035672	4058546150761

Position	Quantity	Description	Part number	EAN
1112 101	1	HALTEBUEGEL	5131043018	4058546262327
1113 102	2	RAD	Item discontinued(5131049198)	
1114 103	1	ANTRIEB	5131043020	4058546262341
1119 104	8	SCHRAUBE	5131035627	4058546150341
1120 105	1	GRIFF	5131042983	4058546261979
1121 106	1	FUEHRUNGSROHR	5131049199	4058546606022
1122 107	1	FUEHRUNGSROHR	5131049200	4058546606039
1123 108	1	HANDGRIFF	5131042978	4058546261924
1124 109	1	ACHSE	5131045994	4058546456269
1125 110	1	ACHSE	5131045993	4058546456252
1127 111	2	SICHERUNGSRING	5131045434	4058546430269
1128 112	1	SEITENTEIL	5131049201	4058546606046
1129 113	1	SEITENTEIL	5131049202	4058546606053
1130 114	5	SCHRAUBE	5131033545	4002395148479
1131 115	1	RAD	5131043010	4058546262242
1133 116	1	MAGNETSCHALTER	5131045459	4058546430511
1136 117	1	HEBEL	5131049203	4058546606060
1137 118	1	GRIFF	5131049204	4058546606077
1138 119	1	GEHAEUSE	5131042969	4058546261832
1139 120	1	DRUECKER	5131042988	4058546262020
1017 121	1	Ersatzmesser 36 V Rasenmaeher, 51 cm	5132004639	4892210185921