

HD18PXP-H10202C Akku-Expander IN2

4933441774 - HD18PXP-H10202C IN2 - 4000427255

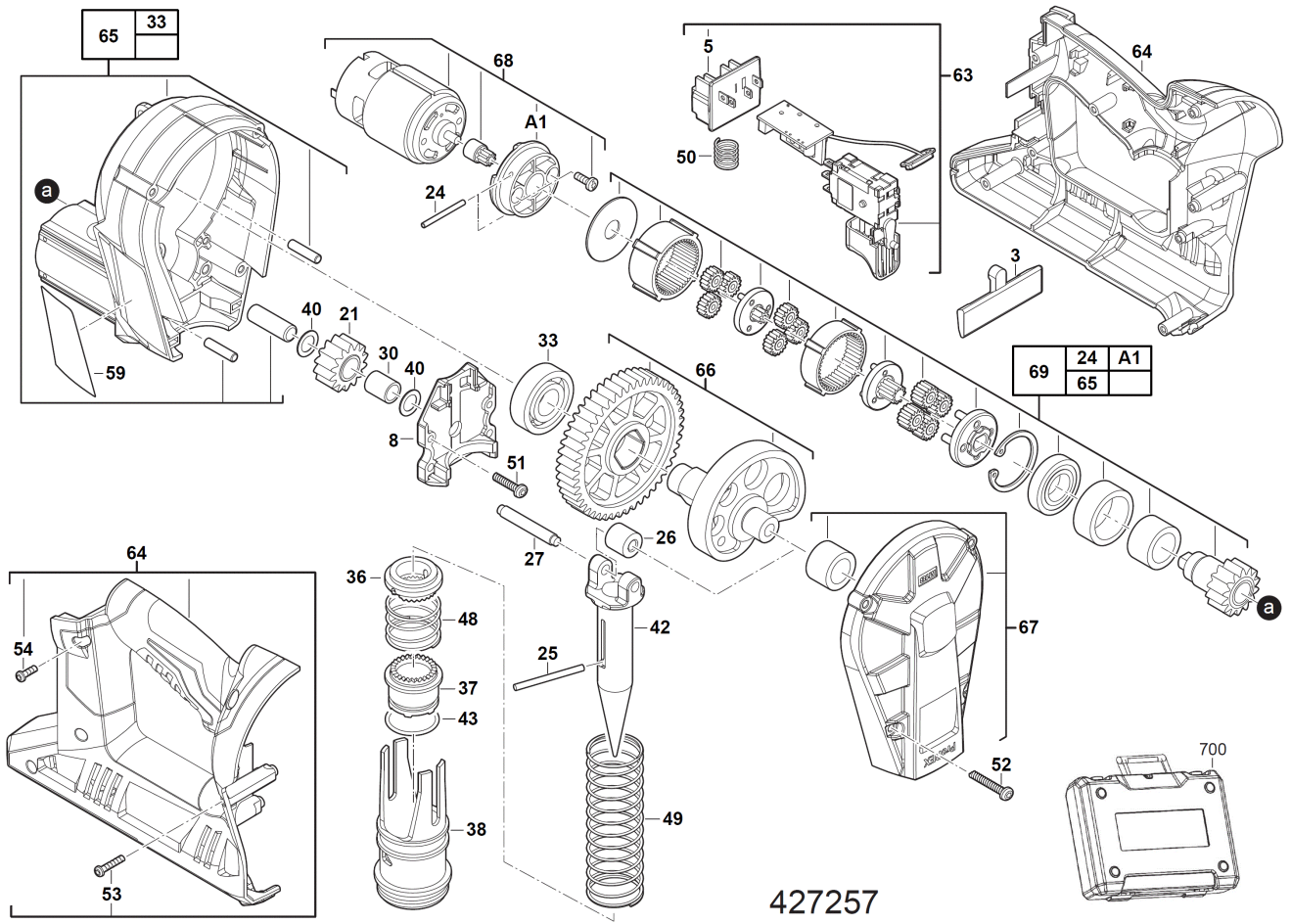



Position	Quantity	Description	Part number	EAN
0003 1	1	EINSCHALTSPERRE	521623001	4002395856817
0005 2	1	KLEMMLEISTE	302119005	4002395856152
0008 3	1	MEMBRANE	641678001	4002395856831
0021 4	1	ZWISCHENRAD	Item discontinued(611241001)	
0024 5	1	STIFT	Item discontinued(672281001)	
0025 6	1	BOLZEN	672320001	4002395846634
0026 7	1	Lagerrolle	692341002	4002395846689
0027 8	1	BOLZEN	4931441173	4002395867226
0030 9	1	NADELLAGER	Item discontinued(681471001)	
0033 10	1	KUGELLAGER	Item discontinued(671013003)	
0036 11	1	MITNEHMERSCHEIBE	611044001	4002395846993
0037 12	1	MANSCHETTE	611260001	4002395857067
0038 13	1	GESTELL	692561001	4002395854769
0040 14	1	SCHEIBE	633487001	4002395856848
0042 15	1	SPINDEL	692560001	4002395854752
0043 16	1	O-Ring	562464001	4002395846986
0048 17	1	FEDER	692471001	4002395847013
0049 18	1	FEDER	692472002	4002395854745
0050 19	1	FEDER	4931408243	4002395814466
0051 20	1	SCHRAUBE	661004001	4002395820429
0052 21	1	SICHERUNGSSCHRAUBE	661004002	4002395854097
0053 22	1	SCHRAUBE	660031016	4002395825172
0054 23	1	SCHRAUBE	660031017	4002395825189
0059 24	1	FIRMENSCHILD	940038262	4002395854776
0063 25	1	SCHALTER M.ELEKTRO.	201320006	4002395854080
0064 26	1	HANDGRIFF KOMPL.	200447010	4002395854042
0065 27	1	GETRIEBEKASTEN	200001015	4002395854011
0066 28	1	GETRIEBESATZ	201079004	4002395854073
0067 29	1	DECKEL-SET	200990012	4002395854066
0068 30	1	MOTOREINHEIT	200663005	4002395854059
0069 31	1	GETRIEBEKASTEN	200281044	4002395854035
0700 32	1	TRANSPORTKOFFER	Item discontinued(200230021)	