

C18ID-32C AKKU-SCHLAGSCHRAUBER IN2

4933411120 - C18ID-32C - 4000431318

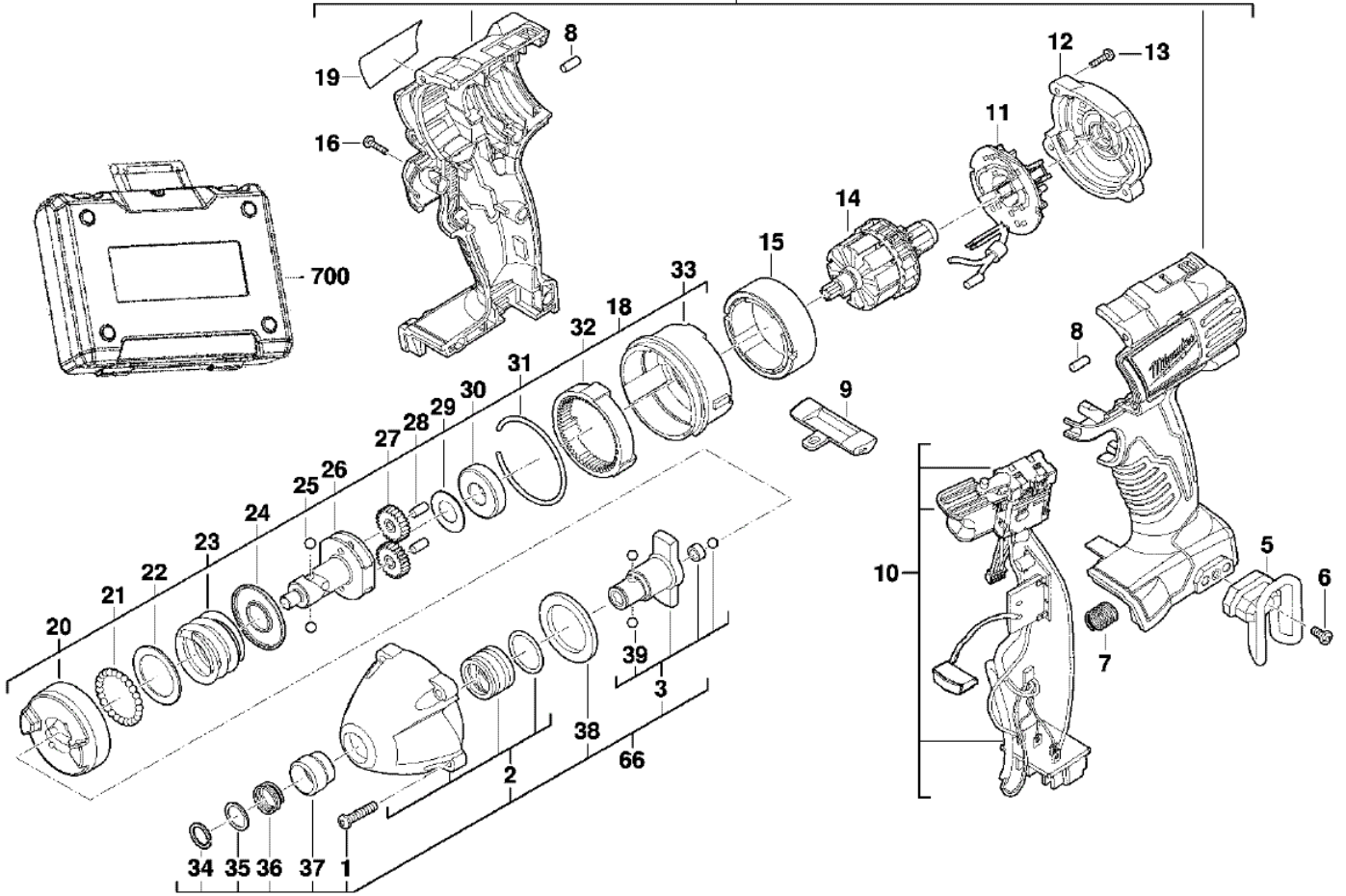



Position	Quantity	Description	Part number	EAN
0001 1	4	SCHRAUBE	201094001	4002395802616
0002 2	1	GETRIEBEKOPF	201093001	4002395802609
0003 3	1	AMBOSS	Item discontinued(201086001)	
0005 4	1	HAKEN	Item discontinued(201066001)	
0006 5	1	SCHRAUBE	Item discontinued(201097001)	
0007 6	1	FEDER	201067001	4002395802340
0008 7	8	DAEMPUNGSELEMENT	201065001	4002395802326
0009 8	1	FUEHRUNG	201063001	4002395802319
0010 9	1	SCHALTER-SET	Item discontinued(4931433508)	
0011 10	1	KOHLEBUERSTE	4931433300	4002395899395
0012 11	1	ABDECKUNG	201062001	4002395802302
0013 12	1	SCHRAUBE	Item discontinued(201096001)	
0014 13	1	MOTOR	201303002	4002395846849
0015 14	1	FELD F. ELEKTROMOTOR	201070001	4002395802371
0016 15	7	SCHRAUBE	Item discontinued(201095001)	
0017 16	1	GEHAEUSE	201061002	4002395846818
0018 17	1	GETRIEBEGEHAEUSE	Item discontinued(201071001)	
0019 18	1	LEISTUNGSSCHILD	Item discontinued(4931433510)	
0020 19	1	HAMMER	Item discontinued(201085001)	
0021 20	30	KUGEL	Item discontinued(201084001)	
0022 21	1	SCHEIBE	201083001	4002395802500
0023 22	1	FEDER	201082001	4002395802494
0024 23	1	SCHEIBE	201081001	4002395802487
0025 24	2	KUGEL	201080001	4002395802470
0026 25	1	NOCKENWELLE	Item discontinued(201079001)	
0027 26	2	ZAHNRAD-SET (P2)	201078001	4002395802456
0028 27	1	STIFT	201077001	4002395802449
0029 28	1	SCHEIBE	Item discontinued(201076001)	
0030 29	1	KUGELLAGER	201075001	4002395802425
0031 30	1	REDUZIERSTUECK	201074001	4002395802418
0032 31	1	RING	Item discontinued(201073001)	
0033 32	1	GETRIEBEGEHAEUSE	201072001	4002395802395
0034 33	1	REDUZIERSTUECK	Item discontinued(201091001)	
0035 34	1	SCHEIBE	Item discontinued(201090001)	
0036 35	1	FEDER	201089001	4002395802562
0037 36	1	BUCHSE	Item discontinued(201088001)	
0038 37	1	SCHEIBE	201092001	4002395802593
0039 38	2	KUGEL	201087001	4002395802548
0066 39	1	GEHAEUSE	201099001	4002395802661
0700 40	1	TRANSPORTKOFFER	Item discontinued(201100003)	
0002 41	1	LADEGERAET C1418C IN2	4932352959	4002395376179