

HD18JS-402C AKKU-STICHSÄEGE IN2

4933441405 - HD18JS-402C - 4000447207

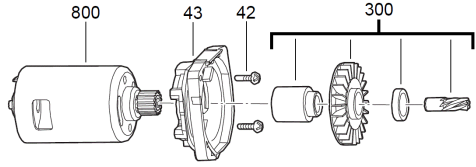

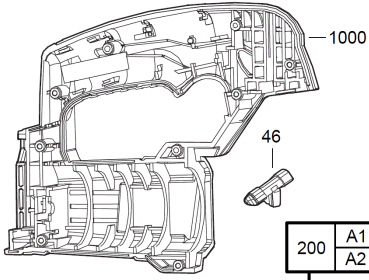

200	A1	A3
	A2	

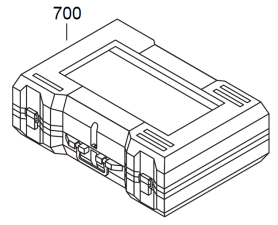
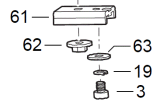
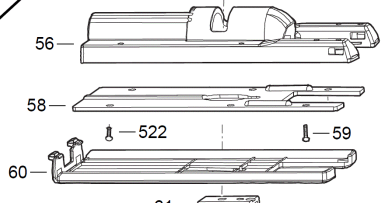
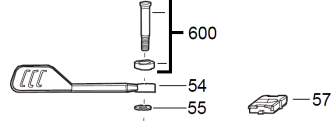
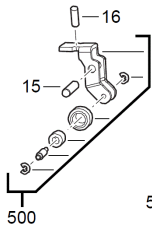
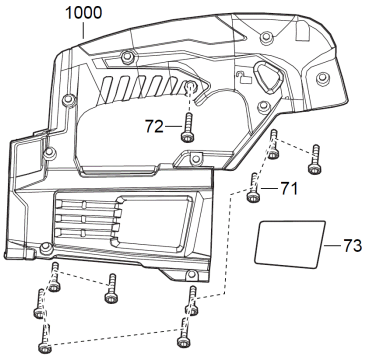
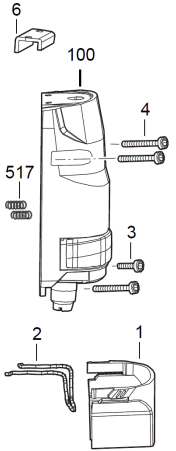
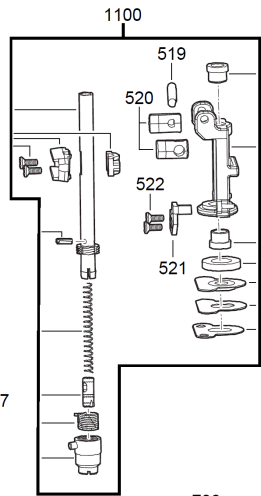
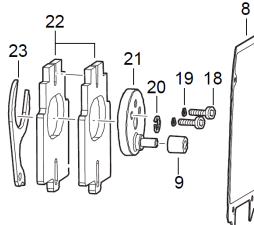
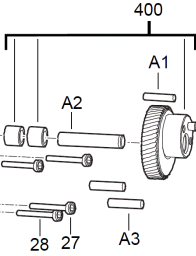
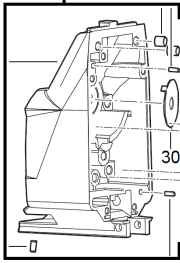
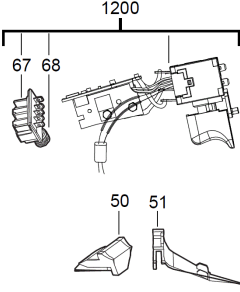
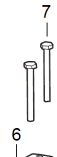
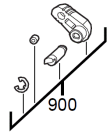

Position	Quantity	Description	Part number	EAN
0001 1	1	ABDECKUNG	201162001	4002395813537
0002 2	1	ABSTANDSHALTER-DRAHT	201163001	4002395813544
0003 3	1	SCHRAUBE	200288041	4002395813018
0004 4	1	SCHRAUBE	Item discontinued(200288042)	
0006 5	1	ANSCHLAG	Item discontinued(201168001)	
0007 6	1	SCHRAUBE	Item discontinued(200288043)	
0008 7	1	DICHTUNG	201170001	4002395813568
0009 8	1	NADELLAGER	Item discontinued(200378002)	
0015 9	1	ZYLINDERSTIFT	201077002	4002395813483
0016 10	1	ZYLINDERSTIFT	201077003	4002395813490
0018 11	1	SCHRAUBE	Item discontinued(200288044)	
0019 12	1	FEDERSCHEIBE	200319013	4002395813179
0020 13	1	SPRENGRING	Item discontinued(201177001)	
0021 14	1	EXZENTERNABE	Item discontinued(201178001)	
0022 15	1	AUSGLEICHGEWICHT	Item discontinued(201179001)	
0023 16	1	ANTRIEBSPLATTE	Item discontinued(201180001)	
0027 17	1	SCHRAUBE	Item discontinued(200288045)	
0028 18	1	SCHRAUBE	Item discontinued(200288054)	
0030 19	1	SCHEIBE	Item discontinued(200319015)	
0042 20	1	SCHRAUBE	Item discontinued(200288046)	
0043 21	1	MOTORTRAEGER	200424002	4002395813407
0046 22	1	KNOPF	Item discontinued(200232004)	
0050 23	1	SPANNZANGE	Item discontinued(201193001)	
0051 24	1	LUFTFUEHRUNG	Item discontinued(201194001)	
0054 25	1	HEBEL	201196001	4002395813636
0055 26	1	SCHEIBE	200319016	4002395813193
0056 27	1	GRUNDPLATTE	201198001	4002395813643
0057 28	1	EINLEGETEIL	Item discontinued(201199001)	
0058 29	1	GLEITBLECH	201200001	4002395813667
0059 30	1	SCHRAUBE	Item discontinued(200288047)	
0060 31	1	GLEITSCHUH	201202001	4002395813674
0061 32	1	KLEMMSTUECK	201203001	4002395813681
0062 33	1	MUTTER	201204001	4002395813698
0063 34	1	SCHEIBE	200319017	4002395813209
0067 35	1	VERBINDUNGSSTECKER	4931441229	4002395870073
0068 36	1	FEDER	201206001	4002395813704
0071 37	9	SCHRAUBE (Pak 9)	Item discontinued(200288048)	
0072 38	1	SCHRAUBE	4931447522	4002395884124
0073 39	1	LEISTUNGSSCHILD	Item discontinued(4931447233)	
0100 40	1	GEHAEUSEKAPPE	Item discontinued(200990004)	
0200 41	1	GETRIEBE-SET	200727002	4002395813223
0300 42	1	RITZEL	200308003	4002395813384
0400 43	1	GETRIEBERAD	Item discontinued(200936002)	
0500 44	1	FUEHRUNGSSTUECK	200984002	4002395813476
0517 45	1	FEDER	Item discontinued(201206002)	
0519 46	1	ZYLINDERSTIFT	Item discontinued(200550008)	
0520 47	1	24.	Item discontinued(201124001)	
0521 48	1	PLATTE	Item discontinued(201125001)	
0522 49	1	SCHRAUBE	201097002	4002395813292
0600 50	1	HEBEL	200937002	4002395813452

Position	Quantity	Description	Part number	EAN
0700 51	1	TRANSPORTKOFFER	201213001	4002395813308
0800 52	1	MOTOR	200146061	4002395813360
0900 53	1	HEBEL	200939002	4002395813469
1000 54	1	HANDGRIFFHAELFTE	4931447524	4002395884131
1100 55	1	SPINDEL SATZ	Item discontinued(200941002)	
1200 56	1	SCHALTER	Item discontinued(4931447525)	
0001 57	2	M18B4 LI-ION AKKUMULATOR 4.0AH XXX	4932430063	4002395377244