

# M18CCS66-502C AKKU-KREISSAEGE IN2

4933448160 - M18CCS66-502C - 4000447256

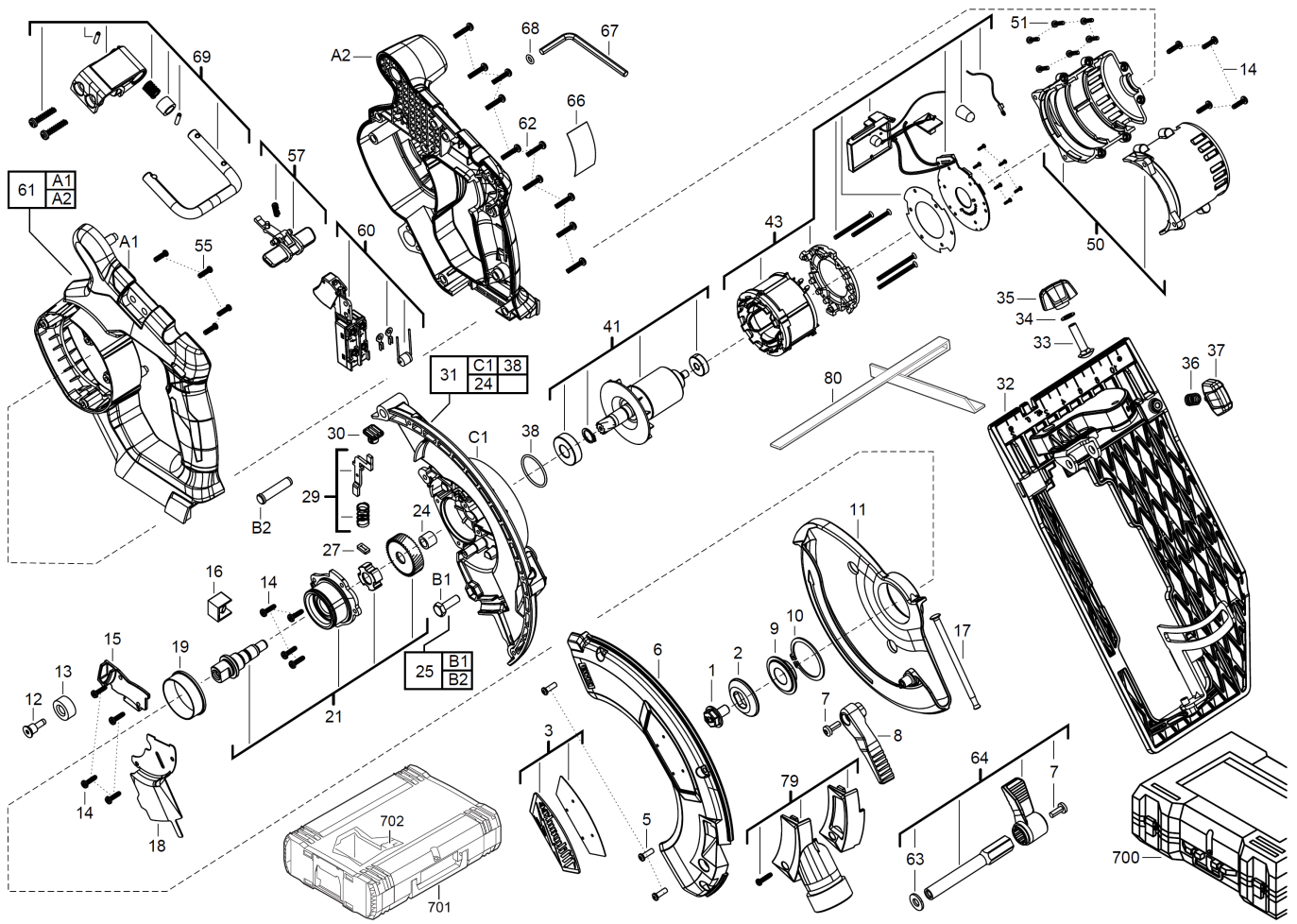



Position	Quantity	Description	Part number	EAN
0001 1	1	SCHRAUBE	4931436453	4002395251018
0002 2	1	FLANSCH	43340485	4058546073374
0003 3	1	FIRMENSCHILD	4931436100	4002395880089
0005 4	3	SCHRAUBE	4931435150	4002395859948
0006 5	1	GETRIEBEKASTEN	Item discontinued(4931436454)	
0007 6	2	SCHRAUBE	06825314	4002395851935
0008 7	1	HEBEL	4931436455	4002395251032
0009 8	1	FLANSCH	4931448349	4002395179572
0010 9	1	DRUCKRING	34600860	4058546072247
0011 10	1	SAEGESCHUTZ	4931436456	4002395251049
0012 11	1	SCHRAUBE	Item discontinued(45040485)	
0013 12	1	GUMMIPUFFER	4931465876	4058546239763
0014 13	12	SCHRAUBE	06825285	4058546068844
0015 14	1	DECKEL	4931436457	4002395251056
0016 15	1	LED ANZEIGETAFEL	4931436458	4002395251063
0017 16	1	FEDER	40500045	4058546072674
0018 17	1	PLATTE	4931436459	4002395251070
0019 18	1	RING	4931436460	4002395251087
0021 19	1	WELLE	4931436461	4002395251094
0024 20	1	NADELLAGER	4931435696	4002395864492
0025 21	1	SCHRAUBENSET	4931436462	4002395251704
0027 22	1	FILZDICHTUNG	45060720	4058546074364
0029 23	1	SPINDELARRETIERUNG	4931436463	4002395251711
0030 24	1	DRUECKER	42421030	4058546073121
0031 25	1	GETRIEBEKASTEN	4931436464	4002395251728
0032 26	1	ABSTANDSHALTER	4931436465	4002395251735
0033 27	1	SCHRAUBE	4931436115	4002395881437
0034 28	1	SCHEIBE	45881560	4058546074845
0035 29	1	DRUECKER	4931436114	4002395881420
0036 30	1	FEDER	40500650	4058546072742
0037 31	1	DRUECKER	4931436113	4002395881413
0038 32	1	O-RING	4931436466	4002395251742
0041 33	1	ANKER F.ELEKTROMOTOR	4931436467	4002395251759
0043 34	1	Feld mit Elektronik	4931469374	4058546271688
0050 35	1	MOTORGEHAEUSE	4931436121	4002395881499
0051 36	6	SCHRAUBE	660570005	4002395827329
0055 37	4	SCHRAUBE	Item discontinued(4931436469)	
0057 38	1	DRUECKER	Item discontinued(4931436123)	
0060 39	1	SCHALTER	4931436122	4002395878703
0061 40	1	GEHAEUSE	4931436470	4002395251780
0062 41	10	SCHRAUBE	06827470	4002395773367
0063 42	1	SCHEIBE	45881545	4058546074821
0064 43	1	TIEFENANSCHLAG	4931436471	4002395251797
0066 44	1	LEISTUNGSSCHILD	Item discontinued(4931436472)	
0067 45	1	SCHLUESSEL	4931436125	4002395878734
0068 46	1	O-RING	34404480	4058546072193
0069 47	1	HAKEN	4931436473	4002395249015
0079 48	1	STAUBABSAUGVORRTG	4931436474	4002395249022
0080 49	1	PARALLELANSCHLAG	4931448018	4002395249732
0700 50	1	TRANSPORTKOFFER	Item discontinued(4931436475)	

Position	Quantity	Description	Part number	EAN
0701 51	1	HD Box Groesse 3	4932453386	4002395143634
0702 52	1	HD Box Einlage 12	Item discontinued(4932453859)	
53	2	M18B5 LI-ION AKKUMULATOR 5.0AH XXX	4932430483	4002395381449