

M12CPD-402X AKKU- SCHLAGBOHRSCHRAUBER IN2

4933441877 - M12CPD-402X 240V EU - 4000448885

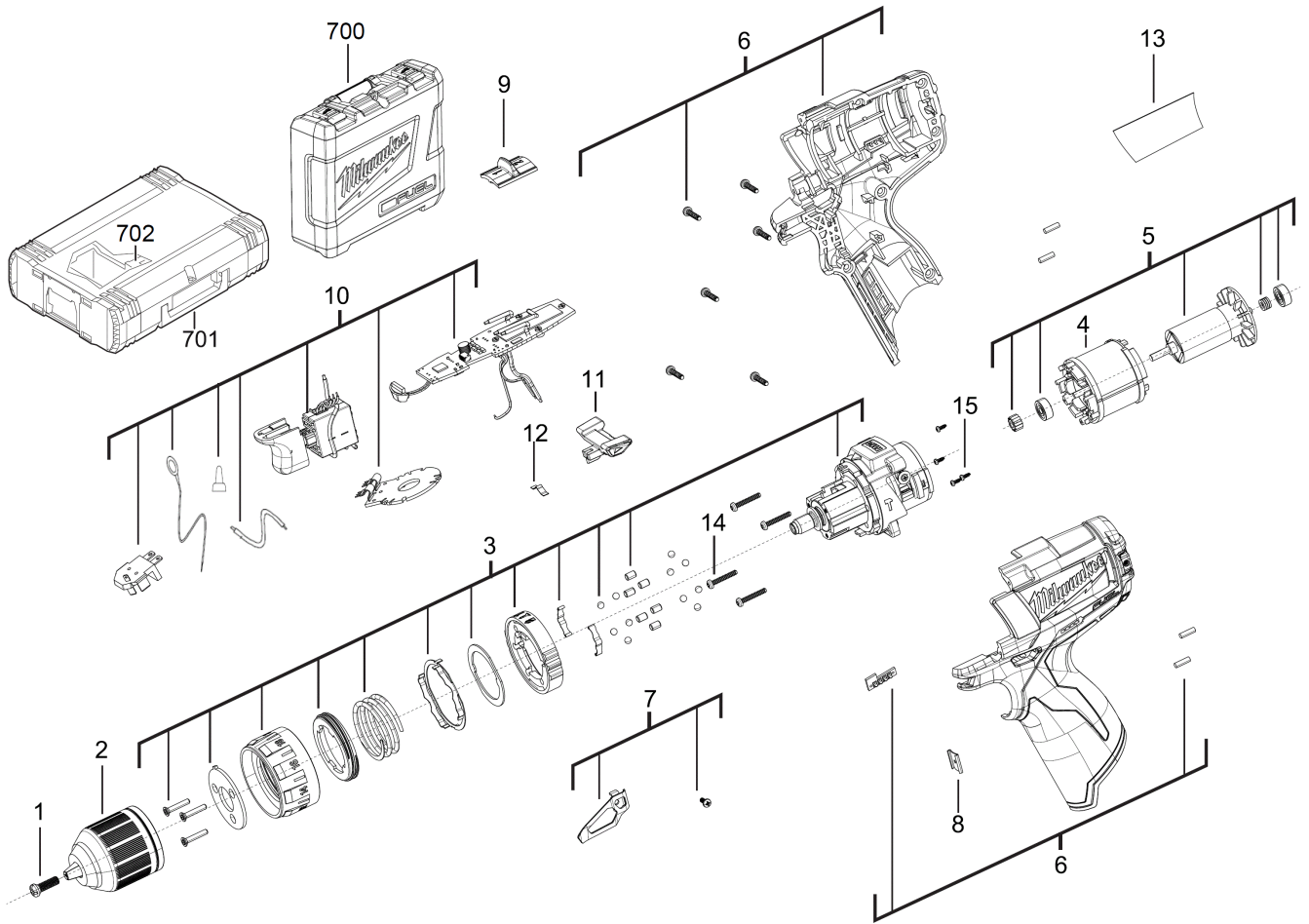



Position	Quantity	Description	Part number	EAN
0001 1	1	SCHRAUBE	4931433297	4002395896684
0002 2	1	BOHRFUTTER	4931435279	4002395902583
0003 3	1	GETRIEBEKASTEN	Item discontinued(4931435740)	
0004 4	1	FELD F. ELEKTROMOTOR	4931456540	4002395162529
0005 5	1	ANKER F.ELEKTROMOTOR	4931435725	4002395866090
0006 6	1	Motorgehaeuse	4931452442	4002395145270
0007 7	1	HALTER	4931435732	4002395866762
0008 8	1	VERBINDUNGSSTUECK	4931436292	4002395252909
0009 9	1	STELLRAD	4931435733	4002395866779
0010 10	1	SCHALTER	4931452443	4002395145287
0011 11	1	KNOPF	4931453615	4002395145263
0012 12	1	FEDERBLECH	4931452341	4002395172528
0013 13	1	LEISTUNGSSCHILD 448885	4931448887	4002395145294
0014 14	1	SCHRAUBE	660230017	4002395839742
0015 15	1	SCHRAUBE	4931435726	4002395866700
0700 16	1	TRANSPORTKASTEN	Item discontinued(4931435730)	
0701 17	1	SYSTEMKOFFER MILWAUKEE GR.1	4932378986	4002395349401
0702 18	1	EINSATZ	4931436215	4002395884209
19	1	M12-18C LADEGERAeT IN2	4932352959	4002395376179
20	2	M12B4 LI-ION AKKUMULATOR 4.0AH XXX	4932430065	4002395377268