

# M18CDD-402C AKKU-BOHRSCHRAUBER IN2

4933440537 - M18CDD-402C - 4000452323

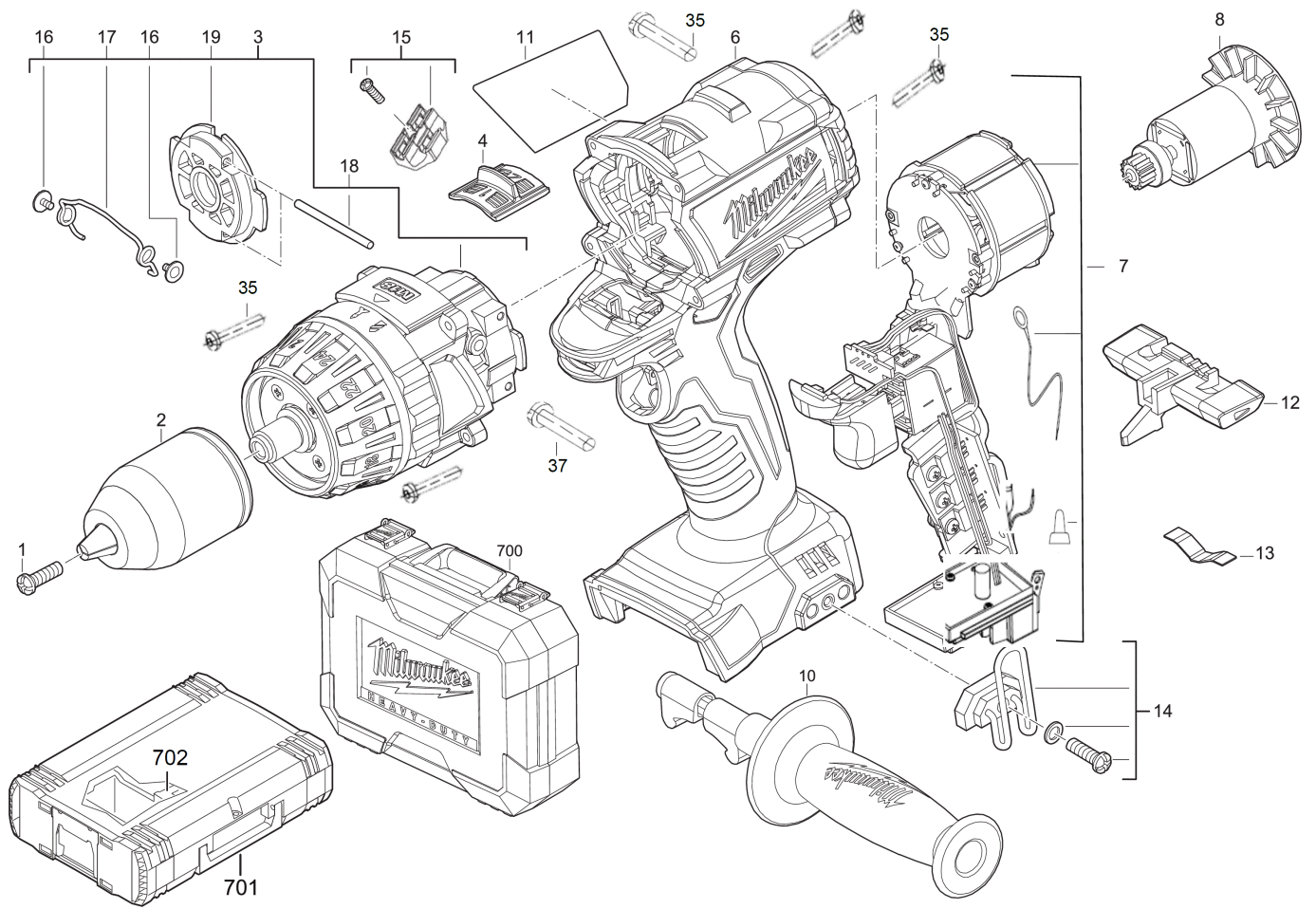



Position	Quantity	Description	Part number	EAN
0001 1	1	SCHRAUBE	4931433297	4002395896684
0002 2	1	BOHRFUTTER	4931435279	4002395902583
0003 3	1	GETRIEBEKASTEN	4931435280	4002395902590
0004 4	1	UMSCHALTER	Item discontinued(4931435281)	
0006 5	1	GEHAEUSE SET	4931452334	4002395171897
0007 6	1	ELEKTRIK VOLLST.	Item discontinued(4931452335)	
0008 7	1	MOTOREINHEIT	4931435277	4002395902569
0010 8	1	HANDGRIFF	4931416738	4002395827480
0011 9	1	LEISTUNGSSCHILD	4931452333	4002395171880
0012 10	1	DRUECKER	4931452336	4002395172504
0013 11	1	FEDERBLECH	4931452341	4002395172528
0014 12	1	HAKEN	4931435274	4002395899982
0015 13	1	BITHALTER	4931435273	4002395901852
0016 14	1	SCHRAUBE	Item discontinued(661262001)	
0017 15	1	UMSCHALTBUEGEL	4931435272	4002395899975
0018 16	1	STIFT	4931435271	4002395902545
0019 17	1	HALTERUNG	4931435270	4002395902538
0035 18	13	SCHRAUBE	660851001	4002395823239
0037 19	2	SCHRAUBE	660570005	4002395827329
0700 20	1	TRANSPORTKASTEN	4931435269	4002395901845
0701 21	1	SYSTEMKOFFER MILWAUKEE GR.1	4932378986	4002395349401
0702 22	1	KOFFEREINSATZ	4931440936	4002395863129
0001 23	2	M18B4 LI-ION AKKUMULATOR 4.0AH XXX	4932430063	4002395377244