

M18FFSDC10-0 AkkuRohrreinigungsgeraet XX

4933459707 - M18FFSDC10-0 - 4000460936

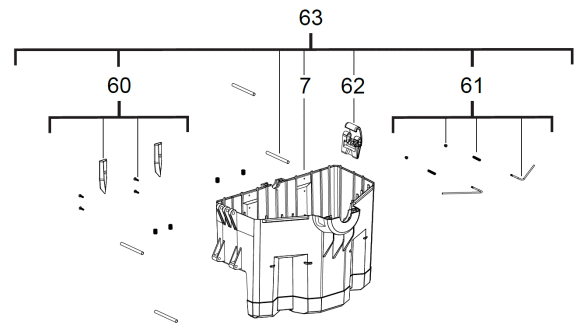

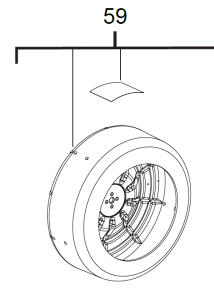

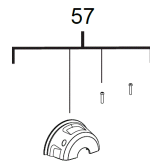
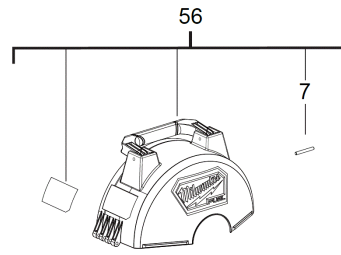
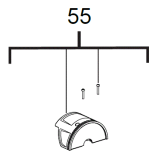
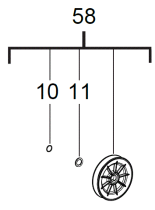
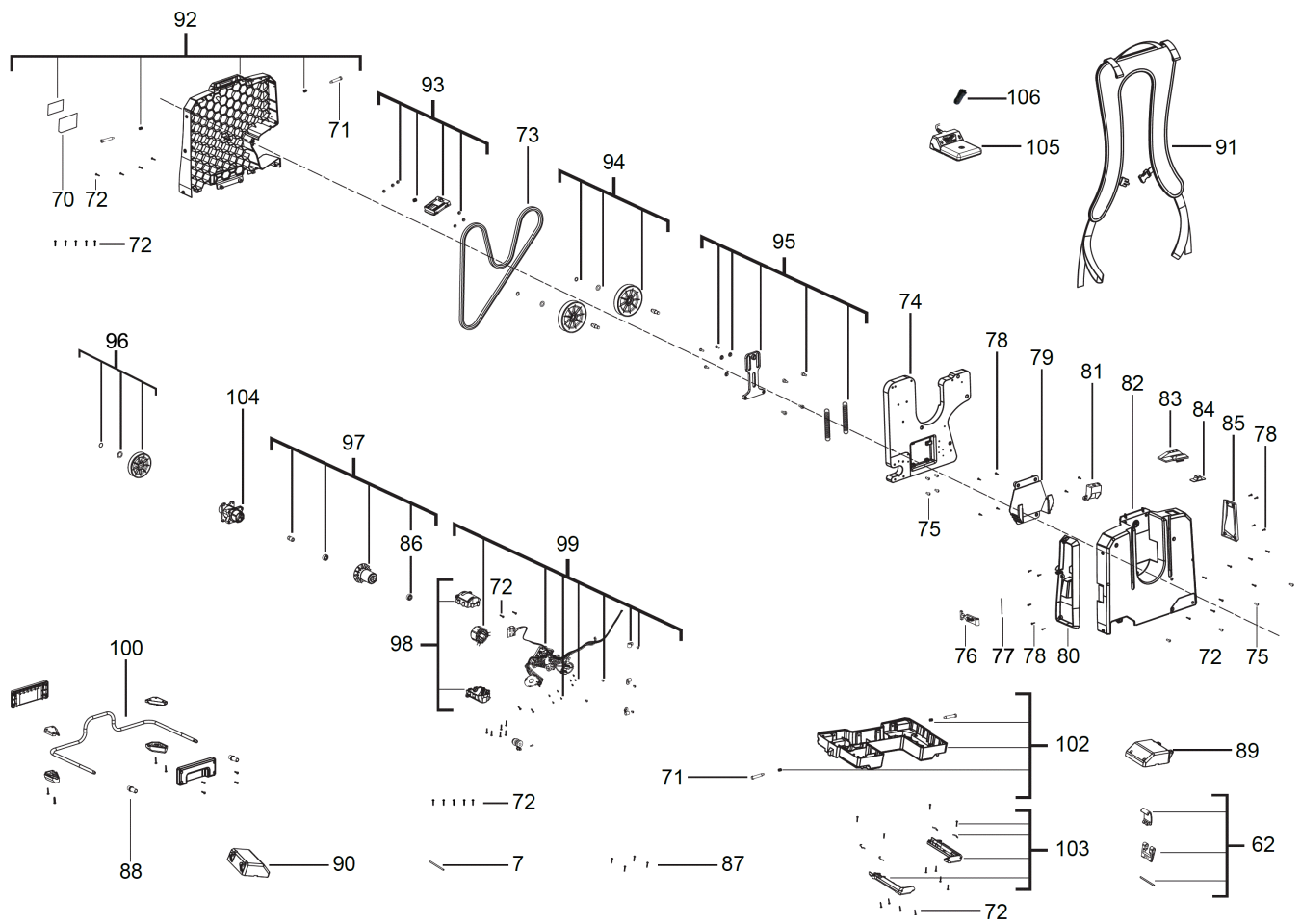

Position	Quantity	Description	Part number	EAN
0007 1	5	STIFT	4931465451	4058546235512
0010 2	1	RETAINING RING	4931465452	4058546235529
0011 3	1	SCHEIBE	4931465453	4058546235536
0022 4	1	KABEL	4931465454	4058546235543
0042 5	1	40,49 x 15 m Spirale f. M18FFSDC	48532773	45242513086
0043 6	1	13 mm x 15m Spirale f. M18FFSDC	48532774	45242513093
0044 7	1	16 mm x 15 m Spirale f. M18FFSDC	48532775	45242513109
0046 8	1	Schaufelkopfborher 38 mm f. M18FFSDC	48532788	45242006120
0047 9	1	Trichterborher fuer M18FFSDC	48532786	45242006106
0048 10	1	Blattborher-Fettaustreiber 38mm M18FFSDC	48532789	45242006137
0049 11	1	Rueckholborher fuer M18FFSDC	48532787	45242006113
0050 12	1	WERKZEUG	4931465455	4058546235550
0055 13	1	LAGERGEHAEUSE	4931465456	4058546235567
0056 14	1	GEHAEUSEDECKEL	4931465457	4058546235574
0057 15	1	LAGERGEHAEUSE	4931465458	4058546235581
0058 16	1	EINZUGSROLLE	4931465459	4058546235598
0059 17	1	FORMTEIL	Item discontinued(4931465460)	
0060 18	1	FUEHRUNGSSTUECK	4931465461	4058546235611
0061 19	2	STANGE	4931465462	4058546235628
0062 20	3	RIEGEL	4931465463	4058546235635
0063 21	1	GEHAEUSE UNTEN	4931465464	4058546235642
0070 22	1	LEISTUNGSSCHILD	4931465465	4058546235659
0071 23	4	SCHRAUBE	4931465466	4058546235666
0072 24	43	SCHRAUBE	4931454853	4058546020279
0073 25	1	RIEMEN	4931465467	4058546235673
0074 26	1	PLATTE	4931465468	4058546235680
0075 27	8	SCHRAUBE	4931436390	4002395249589
0076 28	1	TRAGSCHLAUFE	4931465469	4058546235697
0077 29	1	STIFT	4931465470	4058546235703
0078 30	15	SCHRAUBE	4931465471	4058546235710
0079 31	1	RIEMENSCHUTZ	4931465472	4058546235727
0080 32	1	HALTER	4931465473	4058546235734
0081 33	1	SCHALTERKULISSE	4931465474	4058546235741
0082 34	1	GEHAEUSE	4931465475	4058546235758
0083 35	1	SCHALTERPLATTE	4931465476	4058546235765
0084 36	1	SCHALTSCHIEBER	4931465477	4058546235772
0085 37	1	AUFSCHRIFTENSCHILD	4931465478	4058546235789
0086 38	1	KUGELLAGER	4931436014	4002395875399
0087 39	8	SCHRAUBE	4931465479	4058546235796
0088 40	2	BUECHSE	4931465480	4058546235802
0089 41	1	HALTER	4931465481	4058546235819
0090 42	1	HALTER	4931465482	4058546235826
0091 43	1	TRAGSCHLAUFE	4931465483	4058546235833
0092 44	1	GEHAEUSE	4931465484	4058546235840
0093 45	1	KLEMMLEISTE	4931465485	4058546235857
0094 46	2	EINZUGSROLLE	4931465486	4058546235864
0095 47	1	SPANNEINRICHTUNG	4931465487	4058546235871
0096 48	1	EINZUGSROLLE	4931465488	4058546235888
0097 49	1	MOTOREINHEIT	4931465489	4058546235895
0098 50	1	MOTORGEHAEUSE	4931465490	4058546235901

Position	Quantity	Description	Part number	EAN
0099 51	1	ELEKTRONIK	4931465491	4058546235918
0100 52	1	GRUNDSOCKEL	4931465492	4058546235925
0102 53	1	GEHAEUSE UNTEN	4931465493	4058546235932
0103 54	1	SCHIEBER	4931465494	4058546235949
0104 55	1	GETRIEBEPLATTE	4931465495	4058546235956
0105 56	1	FUSSPEDAL	4931465496	4058546235963
0106 57	1	STECKER	4931466591	4058546278083