

M18FPD2-503X AKKU-SCHLAGBOHRER IN2

4933478518 - M18FPD2-503X - 4000469114

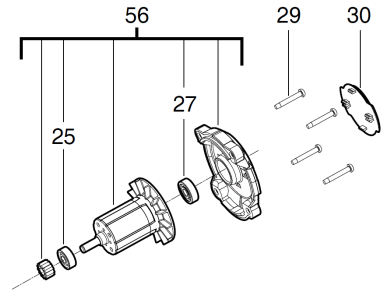

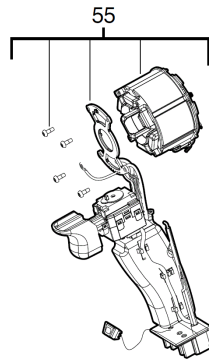
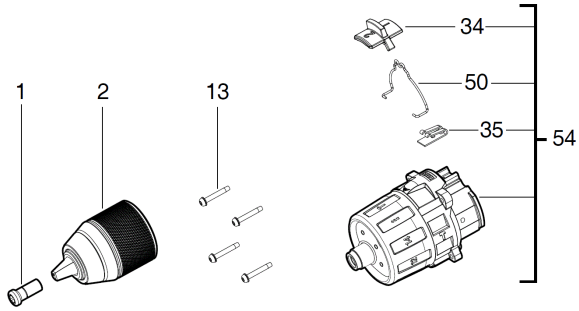
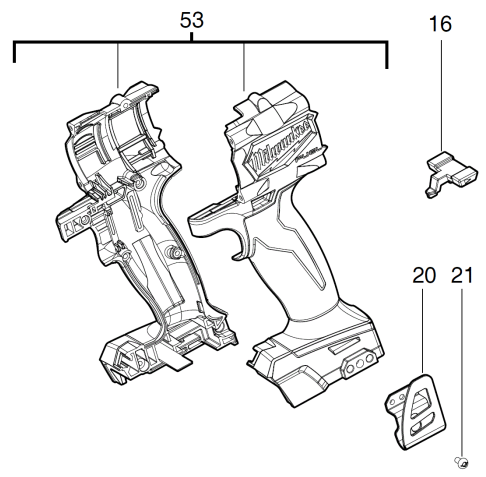
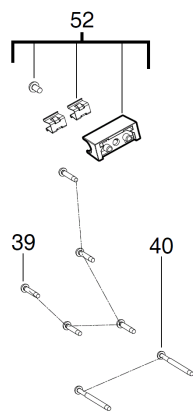
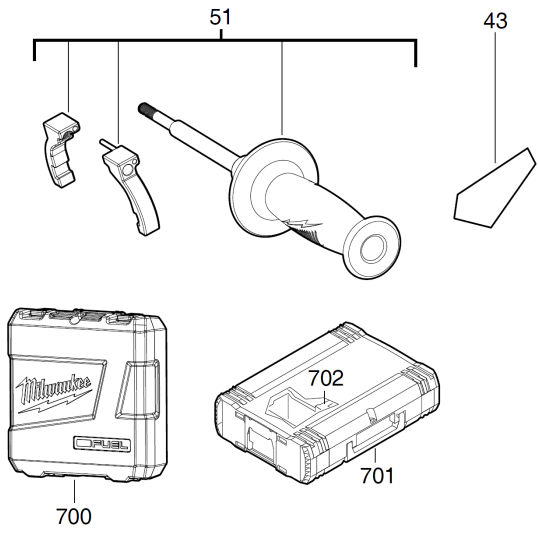

Position	Quantity	Description	Part number	EAN
0001 1	1	SICHERUNGSSCHRAUBE	4931453214	4002395151875
0002 2	1	BOHRFUTTER	4931479550	4058546388652
0013 3	4	SCHRAUBE	4931465984	4058546272012
0016 4	1	SCHIEBER	4931465985	4058546272029
0020 5	1	HAKEN	4931436134	4002395879427
0021 6	1	SCHRAUBE	4931465986	4058546272036
0025 7	1	KUGELLAGER	4931436014	4002395875399
0027 8	1	KUGELLAGER	4931465987	4058546272043
0029 9	4	SCHRAUBE	4931453223	4002395152568
0030 10	1	LAGERSCHILD	4931465988	4058546272050
0034 11	1	SCHALTER	4931465989	4058546272067
0035 12	1	FEDERBLECH	4931465990	4058546272074
0039 13	5	SCHRAUBE	4931453227	4002395153206
0040 14	2	SCHRAUBE	4931454852	4058546020262
0043 15	1	LEISTUNGSSCHILD	4931466001	4058546272180
0050 16	1	DRAHTBUEGEL	4931465992	4058546272098
0051 17	1	ZUSATZHANDGRIFF	4931465993	4058546272104
0052 18	1	BITHALTER	4931465832	4058546239329
0053 19	1	GEHAEUSE	4931465994	4058546272111
0054 20	1	GETRIEBE	4931466002	4058546272197
0055 21	1	ELEKTRONIK	4931465996	4058546272135
0056 22	1	ANKER F.ELEKTROMOTOR	4931465997	4058546272142
0700 23	1	TRANSPORTKOFFER	4931465998	4058546272159
0701 24	1	HD Box Groesse 1	4932453385	4002395146376
0702 25	1	EINSATZ	4931465999	4058546272166