

M18CBLPP2B-502C SET POWERPACK IN2

4933464718 - M18CBLPP2B-502C - 4000469127

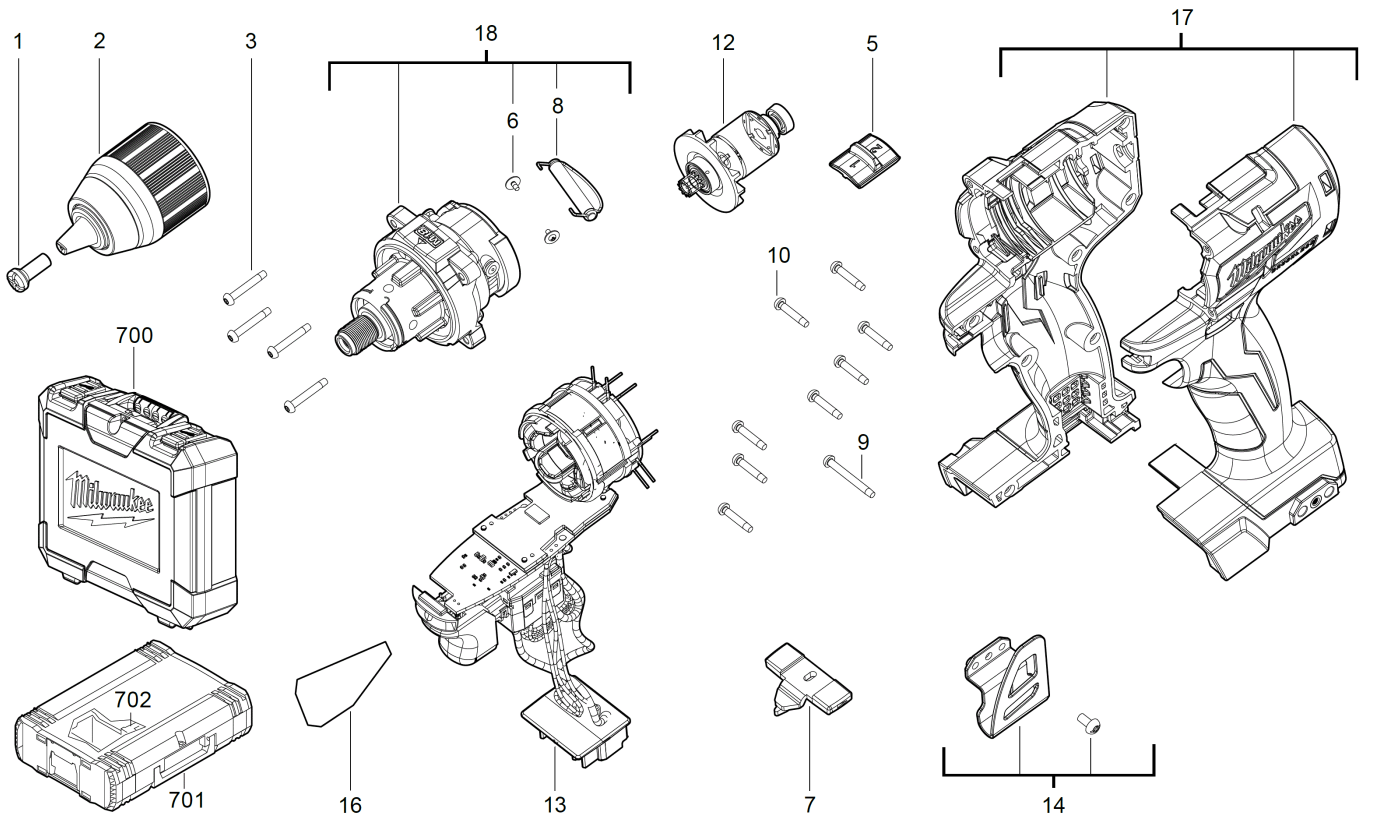

Position	Quantity	Description	Part number	EAN
0001 1	1	SCHRAUBE	4931465497	4058546235970
0002 2	1	BOHRFUTTER	4931465895	4058546239954
0003 3	4	SCHRAUBE	4931453223	4002395152568
0005 4	1	SCHALTER	4931465896	4058546239961
0006 5	2	SCHRAUBE	Item discontinued(661262001)	
0007 6	1	SCHALTER	4931465897	4058546239978
0008 7	1	SCHALTSCHWINGE	4931465508	4058546236083
0009 8	1	SCHRAUBE	4931465898	4058546239985
0010 9	8	SCHRAUBE	4931465499	4058546235994
0012 10	1	ANKER F.ELEKTROMOTOR	4931465899	4058546239992
0013 11	1	ELEKTRONIK	4931465900	4058546240004
0014 12	1	KLAMMER	4931465831	4058546239312
0016 13	1	LEISTUNGSSCHILD	4931466004	4058546272210
0017 14	1	GEHAEUSE	4931465902	4058546240028
0018 15	1	GETRIEBEKASTEN	4931465903	4058546240035
0700 16	1	TRANSPORTKOFFER	4931465904	4058546240042
0701 17	1	HD Box Groesse 1	4932453385	4002395146376
0702 18	1	EINSATZ	4931465905	4058546240059