

AGVM24-230GEX WINKELSCHLEIFER IN2

4933402340 - AGVM24-230GEX - 4000476902

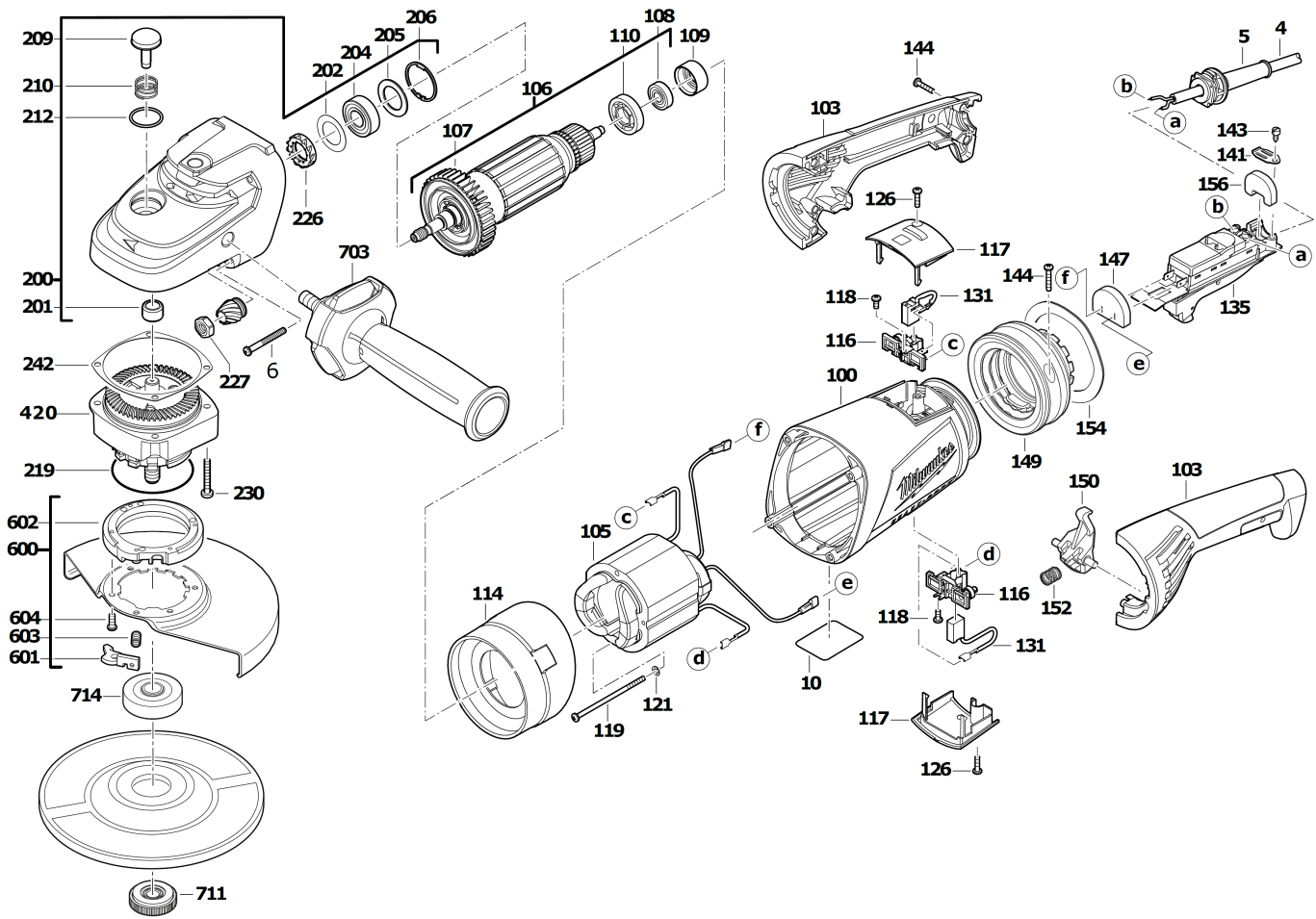



Position	Quantity	Description	Part number	EAN
0004 1	1	ANSCHLUSSLEITUNG	4931455392	4002395174911
0005 2	1	KABELSCHUTZSCHLAUCH	4931387206	4002395746798
0006 3	4	SCHRAUBE	4931622765	4002395699094
0010 4	1	LEISTUNGSSCHILD	4931476916	4058546392932
0100 5	1	MOTORGEHAEUSE MILW 53	4931402268	4002395766086
0103 6	1	SCHALTERGRIFF	4931402176	4002395764143
0105 7	1	FELD F. ELEKTROMOTOR	4931476826	4058546393168
0106 8	1	ANKER VOLLST 53X70 220-240V	4931442695	4002395883752
0107 9	1	VENTILATOR	4931334394	4002395615940
0108 10	1	KUGELLAGER	4931341741	4002395627004
0109 11	1	GUMMIBUCHSE	4931329086	4002395610396
0110 12	1	DICHTRING	4931402219	4002395766123
0114 13	1	LUFTFUEHRUNGSRING MILW 53	4931402269	4002395766093
0116 14	2	BUERSTENHALTER	4931381694	4002395780303
0117 15	2	DECKEL	4931402169	4002395763252
0118 16	2	SCHRAUBE	4931624538	4002395760039
0119 17	2	SCHRAUBE	4931331734	4002395613755
0121 18	2	FEDERSCHEIBE	4931619992	4002395695232
0126 19	2	SCHRAUBE	4931624537	4002395760022
0131 20	1	KOHLEBUERSTEN-SET	4931395107	4002395780518
0135 21	1	SCHALTER	4931476613	4058546391423
0141 22	1	KABELSCHELLE	4931329273	4002395610617
0143 23	1	SCHRAUBE	4931624537	4002395760022
0144 24	6	SCHRAUBE	4931618253	4002395694945
0147 25	1	PART NOT DETAILED	1000063920	
0149 26	1	DAEMPfung	4931455265	4002395174256
0150 27	1	RIEGEL	4931476616	4058546393106
0152 28	1	DRUCKFEDER	4931402039	4002395758630
0154 29	1	FEDERSCHEIBE	4931402029	4002395758616
0156 30	1	STAUBDICHTUNG	4931402286	4002395764754
0200 31	1	GETRIEBEKASTEN	4931402161	4002395765812
0201 32	1	HUELSE	4931621981	4002395696512
0202 33	1	SCHEIBE	4931621629	4002395695720
0204 34	1	KUGELLAGER	4931624305	4002395738595
0205 35	1	SCHEIBE	4931622897	4002395699636
0206 36	1	SPERRING	4931334400	4002395615971
0209 37	1	ARRETIERBOLZEN	4931402166	4002395763191
0210 38	1	DRUCKFEDER	4931329173	4002395610518
0212 39	1	O-RING	4931622764	4002395699087
0219 40	1	DICHTRING	4931624672	4002395791187
0226 41	1	FETTFANGSCHEIBE	4931329178	4002395758258
0227 42	1	MUTTER	4931329494	4002395610693
0230 43	4	SCHRAUBE	4931624147	4002395711055
0242 44	1	DICHTUNG	4931329150	4002395610488
0420 45	1	REPARATURSATZ	4931455623	4002395177882
0600 46	1	SCHUTZHAUBE 230 SW	4931426625	4002395856473
0601 47	1	RASTHEBEL	201256002	4002395801725
0602 48	1	FLANSCH	4931402063	4002395758203
0603 49	1	DRUCKFEDER	4931402089	4002395758234
0604 50	5	SCHRAUBE	4931624491	4002395758142

Position	Quantity	Description	Part number	EAN
0703 51	1	HANDGRIFF	4931398251	4002395764891
0711 52	1	FIXTEC MUTTER XL LOSE	4931468392	4058546320768
0714 53	1	AUTOBALANCER	4931402435	4002395766475