

M18FPP2OP3-852 AKKUWERKZEUGE SET GB2

4933492138 - M18FPP2OP3-852 - 4000477919

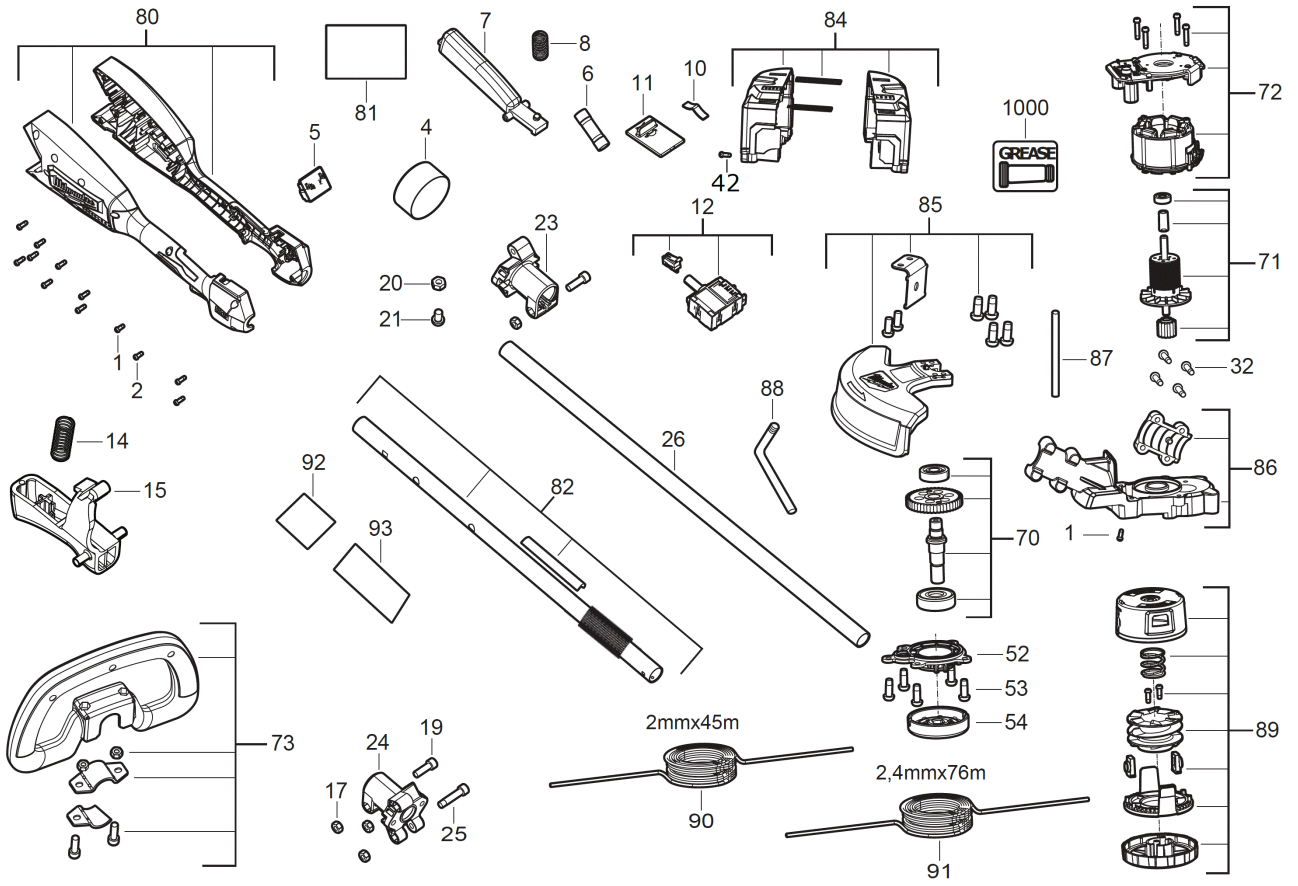

Position	Quantity	Description	Part number	EAN
0001 1	15	SCHRAUBE	4931465326	4058546234263
0002 2	1	SCHRAUBE	4931454800	4058546014179
0004 3	1	AUSGLEICHGEWICHT	4931479323	4058546386382
0005 4	1	ANSCHLUSSKLEMME	4931479324	4058546386399
0006 5	1	ANSCHLUSS	4931479325	4058546386405
0007 6	1	DRUECKER	4931454802	4058546014193
0008 7	1	FEDER	4931454803	4058546014209
0010 8	1	FEDERBLECH	4931452341	4002395172528
0011 9	1	UMSCHALTHEBEL	4931479326	4058546386412
0012 10	1	SCHALTER M.ELEKTRO.	4931479327	4058546386429
0014 11	1	FEDER	4931454808	4058546014254
0015 12	1	DRUECKER	4931454801	4058546014186
0017 13	8	MUTTER	4931479328	4058546386436
0019 14	6	SCHRAUBE	4931465533	4058546236335
0020 15	2	MUTTER	4931479029	4058546365974
0021 16	2	SCHRAUBE	4931479329	4058546386443
0023 17	1	KUPPLUNG	4931479330	4058546386450
0024 18	1	KUPPLUNG	4931479331	4058546386467
0025 19	2	SCHRAUBE	4931479332	4058546386474
0026 20	1	ROHR	4931479333	4058546386481
0032 21	4	SCHRAUBE	4931465543	4058546236434
0042 22	4	SCHRAUBE	660570005	4002395827329
0052 23	1	LAGERSCHILD	4931479334	4058546386498
0053 24	5	SCHRAUBE	4931472832	4058546331344
0054 25	1	ARRETIERBLECH	4931479335	4058546386504
0070 26	1	SPINDELRAD	4931479336	4058546386511
0071 27	1	ROTOR	4931479337	4058546386528
0072 28	1	ELEKTRONIK	4931479338	4058546386535
0073 29	1	HANDGRIFF-SET	4931479339	4058546386542
0080 30	1	HANDGRIFF KOMPL.	4931479340	4058546386559
0081 31	1	LEISTUNGSSCHILD	4931479341	4058546386566
0082 32	1	ROHR	4931479342	4058546386573
0084 33	1	MOTORGEHAEUSE	4931479343	4058546386580
0085 34	1	SCHUTZ	4931479344	4058546386597
0086 35	1	GETRIEBEPLATTE	4931479345	4058546386603
0087 36	1	HALTESTIFT	4931454818	4058546014353
0088 37	1	SCHLUESSEL	4931454817	4058546014346
0092 38	1	SCHAUM STOFFSTUECK	4931479346	4058546386610
0093 39	2	SCHAUM STOFFSTUECK	4931479347	4058546386627
1000 40	1	GETRIEBEFETT	4931443288	4002395255627
0089 41	1	Doppelfadenkopf u. -spule, 2,0mm M18 CLT	4932480180	4058546404659
0090 42	1	Schneidfaden 45m, Faden 2,0 mm	49162712	45242493906
0091 43	1	Schneidfaden 76m, Faden 2,4 mm	49162713	45242493913