

# M18FDD3-402C AKKU-SCHRAUBER IN2

4933492472 - M18FDD3-402C - 4000481305

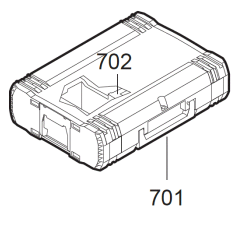

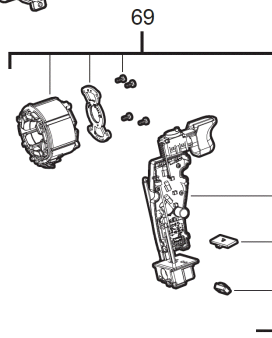
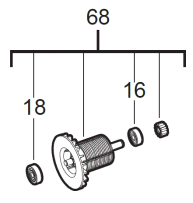
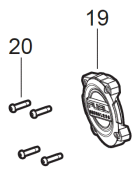
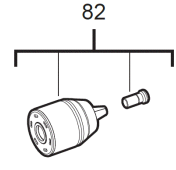
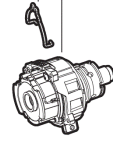
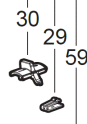
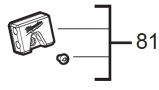
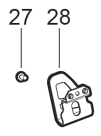
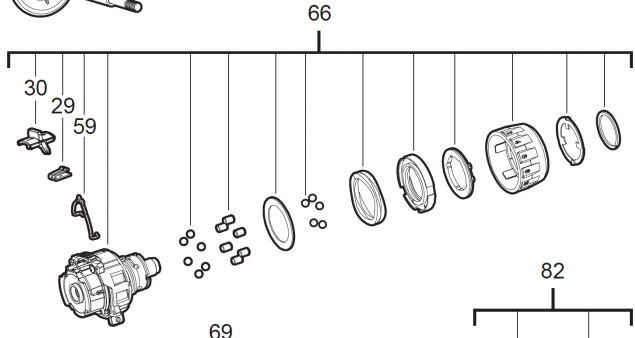
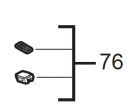
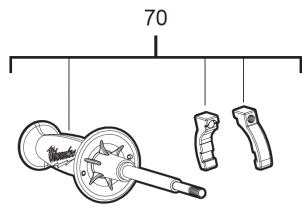
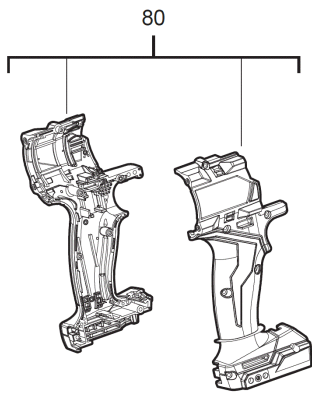

Position	Quantity	Description	Part number	EAN
0012 1	4	SCHRAUBE	4931465984	4058546272012
0016 2	1	KUGELLAGER	4931479944	4058546397074
0018 3	1	KUGELLAGER	4931465987	4058546272043
0019 4	1	ABDECKHAUBE	4931494902	4058546474744
0020 5	9	SCHRAUBE	4931465499	4058546235994
0024 6	1	UMSCHALTHEBEL	4931494903	4058546474751
0025 7	2	SCHRAUBE	4931454852	4058546020262
0027 8	1	SCHRAUBE	4931465986	4058546272036
0028 9	1	HAKEN	4931436134	4002395879427
0029 10	1	FEDER	4931494904	4058546474768
0030 11	1	SCHALTERDRUECKER	4931494905	4058546474775
0059 12	1	FEDER	4931494906	4058546474782
0062 13	1	LEISTUNGSSCHILD	4931494907	4058546474799
0066 14	1	GETRIEBEKASTEN	4931494908	4058546474805
0068 15	1	ANKER F.ELEKTROMOTOR	4931494909	4058546474812
0069 16	1	ELEKTRONIK	4931507219	4058546597306
0070 17	1	HANDGRIFF-SET	4931494911	4058546474836
0076 18	1	LINSE	4931494912	4058546474843
0080 19	1	MOTORGEHAEUSE	4931494913	4058546474850
0081 20	1	HALTER	4931494914	4058546474867
0082 21	1	BOHRFUTTER	4931494915	4058546474874
0701 22	1	HD Box Groesse 1	4932453385	4002395146376
0702 23	1	EINSATZ	4931494916	4058546474881