

C12PXP-I10202C Akku-Expander IN2

4933441730 - C12PXP-I10202C - 4000481501

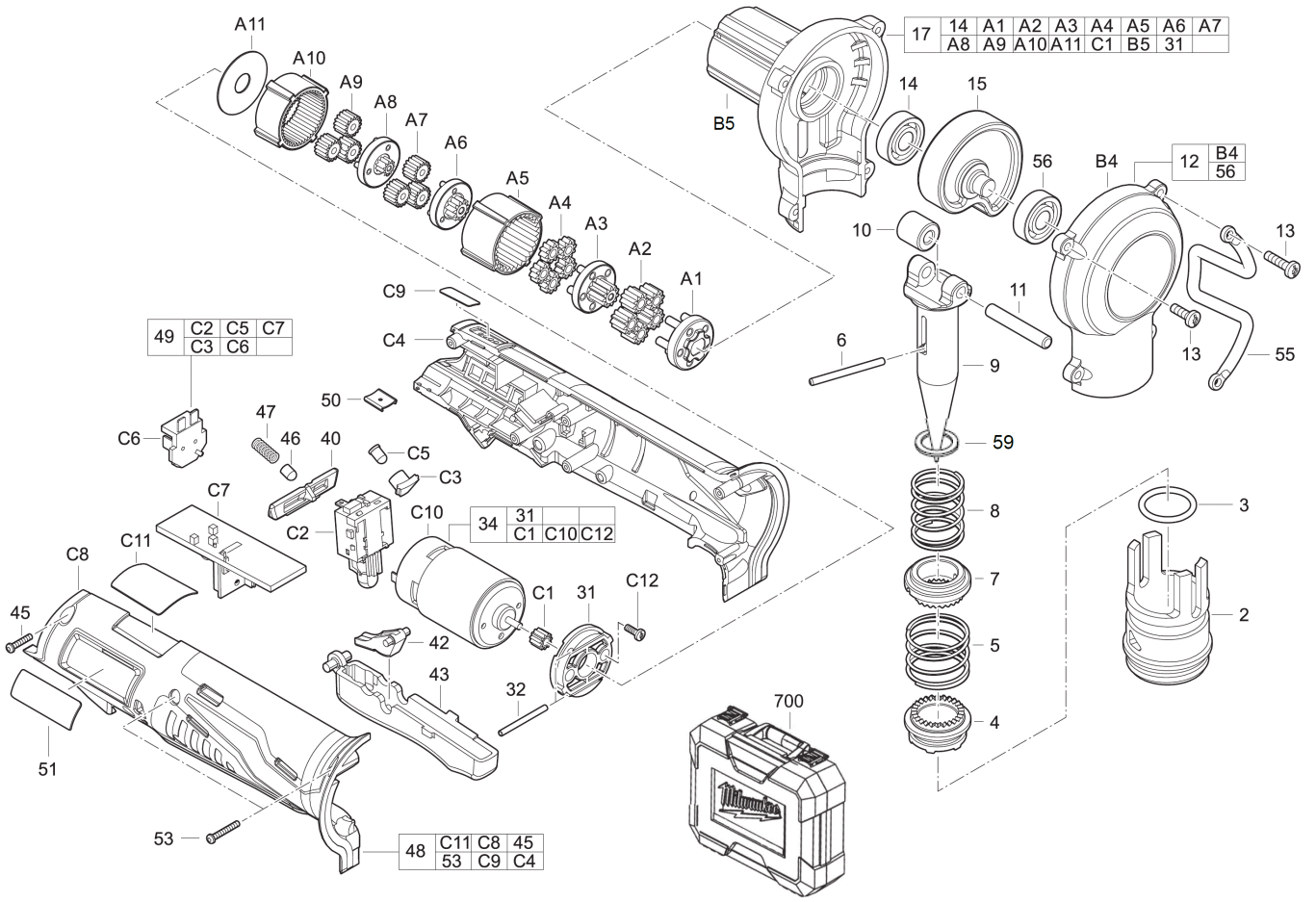



Position	Quantity	Description	Part number	EAN
0002 1	1	WERKZEUGAUFNAHME F. AKKUEXPANDER	4931495469	4058546491376
0003 2	1	O-Ring	562464001	4002395846986
0004 3	1	MANSCHETTE	611045001	4002395846603
0005 4	1	FEDER	692471001	4002395847013
0006 5	1	STIFT	4931479310	4058546386252
0007 6	1	STELLRING	4931479309	4058546386245
0008 7	1	FEDER	4931479308	4058546386238
0009 8	1	SPINDEL	4931479307	4058546386221
0010 9	1	Lagerrolle	692341002	4002395846689
0011 10	1	BOLZEN	4931441173	4002395867226
0012 11	1	GETRIEBEBECKEL	303862001	4002395846900
0013 12	4	SCHRAUBE	661113008	4002395830077
0014 13	1	KUGELLAGER	681326001	4002395846665
0015 14	1	EXZENTER	303862002	4002395846917
0017 15	1	GETRIEBESATZ	4931448990	4002395181551
0031 16	1	MOTORTRAEGER	Item discontinued(4931441174)	
0032 17	2	BEFESTIGUNGSBOLZEN	Item discontinued(680334032)	
0034 18	1	MOTOREINHEIT	201622014	4002395857265
0040 19	1	SCHIEBER	521360001	4002395846962
0042 20	1	SCHALTHEBEL	521359001	4002395846955
0043 21	1	SCHALTER	521358001	4002395846948
0045 22	5	SCHRAUBE	660570005	4002395827329
0046 23	1	SCHALTHUELSE	633289001	4002395831586
0047 24	1	FEDER	692505001	4002395830763
0048 25	1	HANDGRIFF-SET	201488002	4002395846863
0049 26	1	UMSCHALTER	201622013	4002395846894
0050 27	1	VERBINDUNGS-STUECK	631542001	4002395822591
0051 28	1	LEISTUNGSSCHILD	4931495470	4058546491383
0053 29	1	SCHRAUBE	660230009	4002395823222
0055 30	1	KLAMMER	632317002	4002395846610
0056 31	1	KUGELLAGER	Item discontinued(681372001)	
0059 32	1	SCHEIBE	4931466760	4058546279776
0700 33	1	TRANSPORTKOFFER	200230019	4002395846856