

# M18BLDDRC-502C Akku-Bohrschrauber IN2

4933492835 - M18BLDDRC-502C - 4000481709

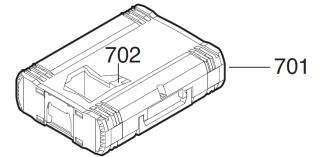

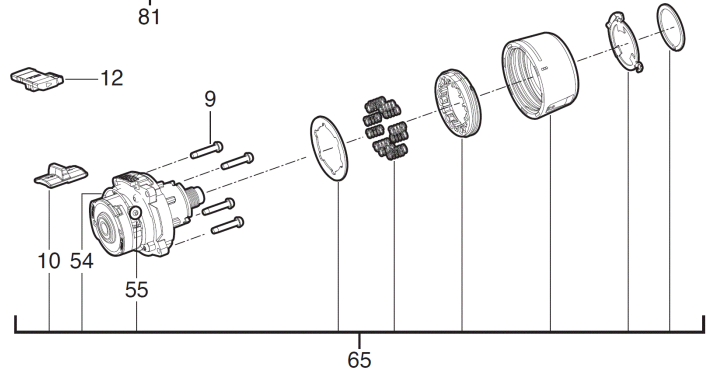
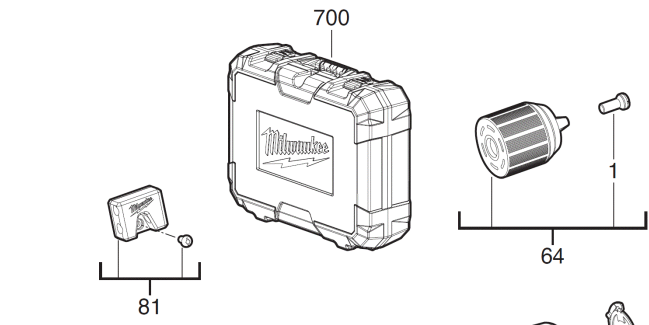
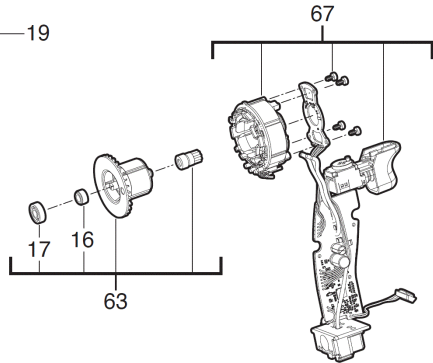
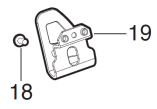
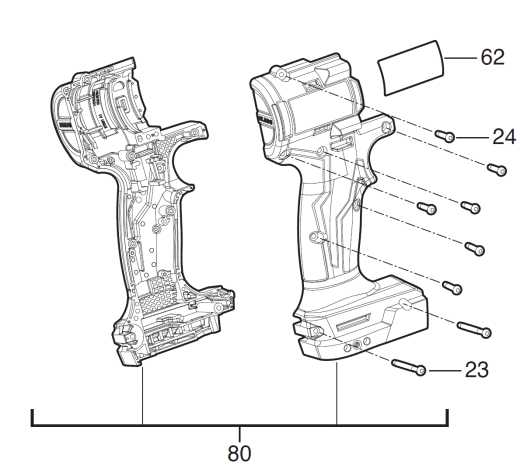

Position	Quantity	Description	Part number	EAN
0001 1	1	SCHRAUBE	4931465497	4058546235970
0009 2	4	SCHRAUBE	4931465984	4058546272012
0010 3	1	UMSCHALTHEBEL	4931495916	4058546495848
0012 4	1	HEBEL	4931495917	4058546495855
0016 5	1	BUECHSE	4931495918	4058546530556
0017 6	1	KUGELLAGER	4931495839	4058546495077
0018 7	1	SCHRAUBE	4931465986	4058546272036
0019 8	1	HAKEN	4931436134	4002395879427
0023 9	2	SCHRAUBE	4931454852	4058546020262
0024 10	6	SCHRAUBE	4931465499	4058546235994
0054 11	1	SCHALTSCHWINGE	4931465508	4058546236083
0055 12	2	SCHRAUBE	Item discontinued(661262001)	
0062 13	1	LEISTUNGSSCHILD	4931495919	4058546530563
0063 14	1	ANKER F.ELEKTROMOTOR	4931495920	4058546530570
0064 15	1	BOHRFUTTER	4931495921	4058546530587
0065 16	1	GETRIEBEKASTEN	4931495922	4058546530594
0067 17	1	ELEKTRONIK	4931495923	4058546530600
0080 18	1	GEHAEUSE	4931495924	4058546530617
0081 19	1	BITHALTER	4931494824	4058546473969
0700 20	1	TRANSPORTKASTEN	4931495925	4058546530624
0701 21	1	HD Box Groesse 1	4932453385	4002395146376
0702 22	1	EINSATZ	4931495926	4058546530631