

M12BDD-402C AKKU-SCHRAUBER IN2

4933441925 - M12BDD-402C - 4000481723

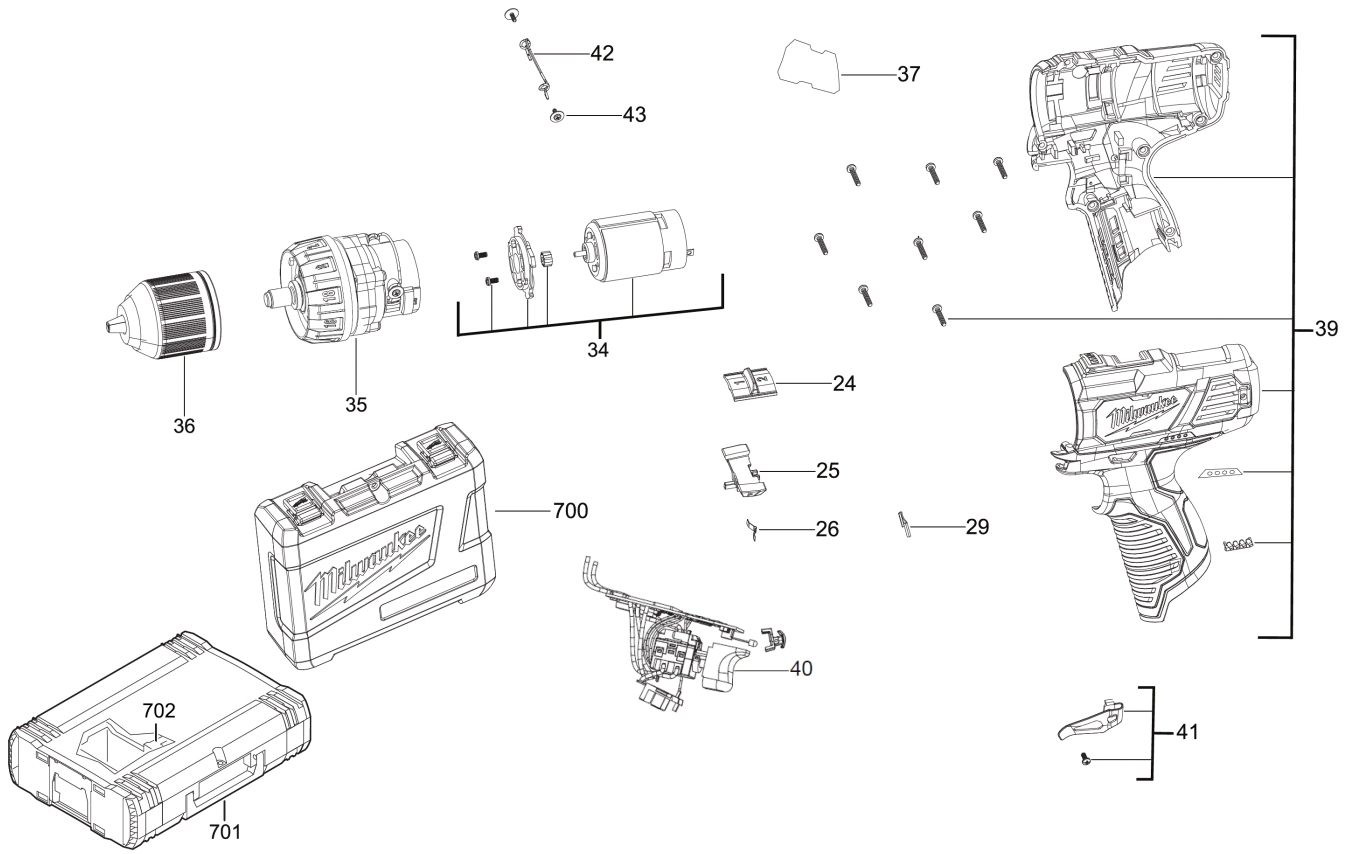



Position	Quantity	Description	Part number	EAN
0001 1	1	SCHRAUBE	660120008	4002395823208
0024 2	1	REGELVORRICHT.	4931435969	4002395886692
0025 3	1	STOESSEL	4931441969	4002395179251
0026 4	1	FEDERBLECH	4931452341	4002395172528
0029 5	1	VERBINDUNGS-STUECK	631542001	4002395822591
0034 6	1	MOTOREINHEIT	4931435971	4002395887316
0035 7	1	GETRIEBE-SET	4931495489	4058546491574
0036 8	1	SCHNELLSP.BOHRF.	4931494852	4058546474249
0037 9	1	LEISTUNGSSCHILD	4931495490	4058546491581
0039 10	1	GEHAEUSE	4931435974	4002395887347
0040 11	1	SCHALTER-SET	4931435975	4002395887354
0041 12	1	KLAMMER	4931435760	4002395866175
0042 13	1	SCHALTHEBEL	4931435976	4002395887361
0043 14	1	SCHRAUBE	Item discontinued(661262001)	
0700 15	1	TRANSPORTKASTEN	4931435977	4002395887378
0701 16	1	SYSTEMKOFFER MILWAUKEE GR.1	4932378986	4002395349401
0702 17	1	EINSATZ	4931436215	4002395884209
18	1	M12-18C LADEGERAeT IN2	4932352959	4002395376179
19	2	M12B2 LI-ION AKKUMULATOR 2.0AH XXX	4932430064	4002395377251