

# M18FCOS230-0 AKKU-TRENNSCHLEIFER IN2

4933471696 - M18FCOS230-0 - 4000481994

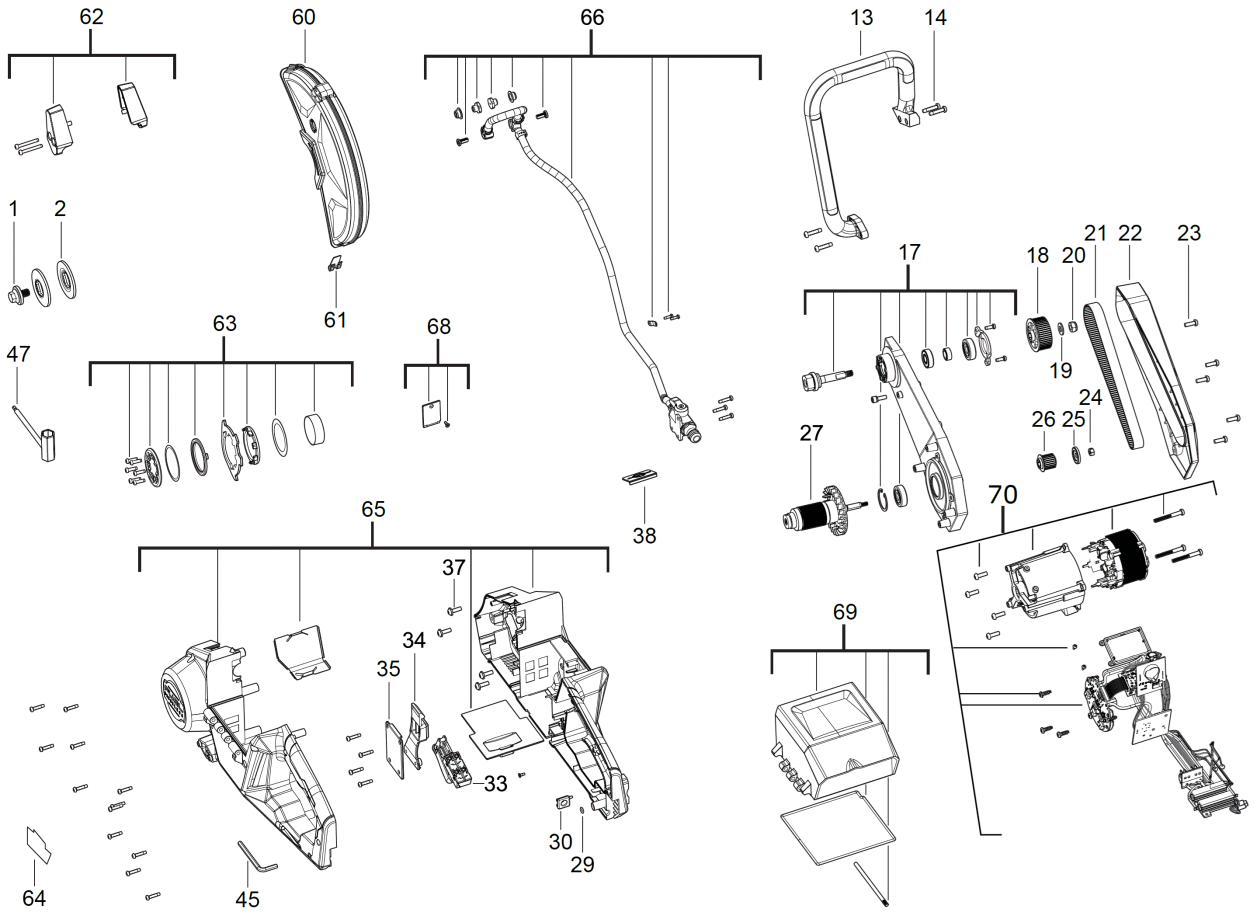



Position	Quantity	Description	Part number	EAN
0001 1	1	FLANSCH	4931472594	4058546328962
0002 2	2	FLANSCH	4931472595	4058546328979
0013 3	1	GRIFF	4931472597	4058546328993
0014 4	4	SCHRAUBE	4931465543	4058546236434
0017 5	1	TRAEGER	4931472598	4058546329006
0018 6	1	ANTRIEBSROLLE	4931472599	4058546329013
0019 7	1	SCHEIBE	4931465110	4058546232108
0020 8	1	MUTTER	4931472600	4058546329020
0021 9	1	RIEMEN	4931472601	4058546329037
0022 10	1	ABDECKUNG	4931472602	4058546329044
0023 11	5	SCHRAUBE	4931453972	4002395282593
0024 12	1	MUTTER	671686001	4002395824526
0025 13	1	SCHEIBE	4931472603	4058546329051
0026 14	1	ANTRIEBSROLLE	4931472604	4058546329068
0027 15	1	ROTOR	4931472605	4058546329075
0029 16	1	O-RING	34404480	4058546072193
0030 17	1	GUMMIPLATTE	4931472606	4058546329082
0033 18	1	SCHALTER	4931472607	4058546329099
0034 19	1	RIEGEL	4931472608	4058546329105
0035 20	1	HALTEBLECH	4931472609	4058546329112
0037 21	4	SCHRAUBE	4931453939	4002395280476
0038 22	1	HEBEL	4931472610	4058546329129
0045 23	1	SCHLUESSEL	4931472611	4058546329136
0047 24	1	SCHLUESSEL	4931472612	4058546329143
0060 25	1	SCHUTZ	4931472613	4058546329150
0061 26	1	RIEGEL	4931472614	4058546329167
0062 27	1	TRAEGER	4931472615	4058546329174
0063 28	1	VERBINDUNGSSET	4931472616	4058546329181
0064 29	1	LEISTUNGSSCHILD	4931506819	4058546561338
0065 30	1	GEHAEUSE	4931472618	4058546329204
0066 31	1	SCHLAUCH	4931472619	4058546329211
0068 32	1	AKKUKAPPE	4931472620	4058546329228
0069 33	1	AKKUKAPPE	4931472621	4058546329235
0070 34	1	ELEKTRONIK	4931506820	4058546561345