

M18FHIW2F12-0X Akku-Schlagschrauber XXX

4933492782 - M18FHIW2F12-0X - 4000497740

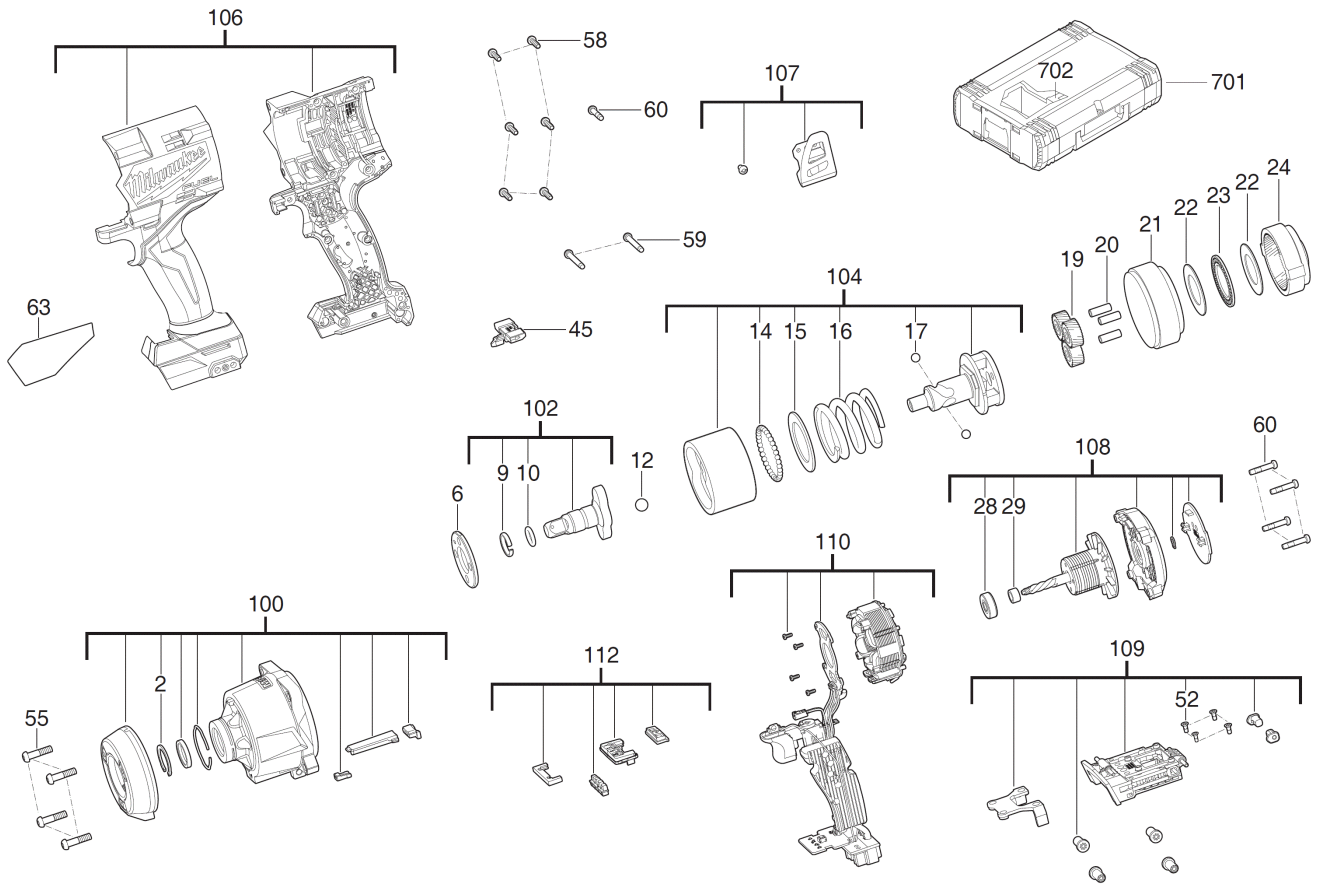



Position	Quantity	Description	Part number	EAN
0002 1	1	SICHERUNGSRING	4931453319	4002395162451
0006 2	1	SCHEIBE	4931496133	4058546532703
0009 3	1	SPRENGRING	4931416493	4002395898374
0010 4	1	O-RING	4931416492	4002395898367
0012 5	1	KUGEL	4931496134	4058546532710
0014 6	31	KUGEL	4931496165	4058546533021
0015 7	1	SCHEIBE	4931496166	4058546533038
0016 8	1	FEDER	4931496167	4058546533045
0017 9	2	KUGEL	4931496135	4058546532727
0019 10	3	PLANETENGETRIEBE	4931496136	4058546532734
0020 11	3	STIFT	4931496137	4058546532741
0021 12	1	DICHTUNG	4931496138	4058546532758
0022 13	2	SCHEIBE	4931496139	4058546532765
0023 14	1	NADELLAGER	4931496140	4058546532772
0024 15	1	ZAHNRAD	Item discontinued(4931496141)	
0028 16	1	LAGER	4931496142	4058546532796
0029 17	1	BUECHSE	4931496143	4058546532802
0045 18	1	KNOPF	4931496150	4058546532871
0052 19	4	SCHRAUBE	4931472925	4058546332273
0055 20	4	SCHRAUBE	4931496151	4058546532888
0058 21	6	SCHRAUBE	4931496152	4058546532895
0059 22	2	SCHRAUBE	4931465325	4058546234256
0060 23	5	SCHRAUBE	4931465324	4058546234249
0063 24	1	LEISTUNGSSCHILD	4931496168	4058546533052
0100 25	1	GETRIEBEPLATTE	4931496169	4058546533069
0102 26	1	AMBOSS	4931496170	4058546533076
0104 27	1	SCHLAGBOLZEN	4931496171	4058546533083
0106 28	1	GEHAEUSE	4931496158	4058546532956
0107 29	1	KLAMMER	4931465831	4058546239312
0108 30	1	ROTOR	4931496159	4058546532963
0109 31	1	BAUSATZ	4931496160	4058546532970
0110 32	1	ELEKTRONIK	4931507036	4058546595470
0112 33	1	SCHALTER	4931496162	4058546532994
0701 34	1	HD Box Groesse 1	4932453385	4002395146376
0702 35	1	EINSATZ	4931496164	4058546533014