

# **M18FHET60-802 Akku-Heckenschere 60cm IN2**

**4933493291 - M18FHET60-802 - 4000503130**

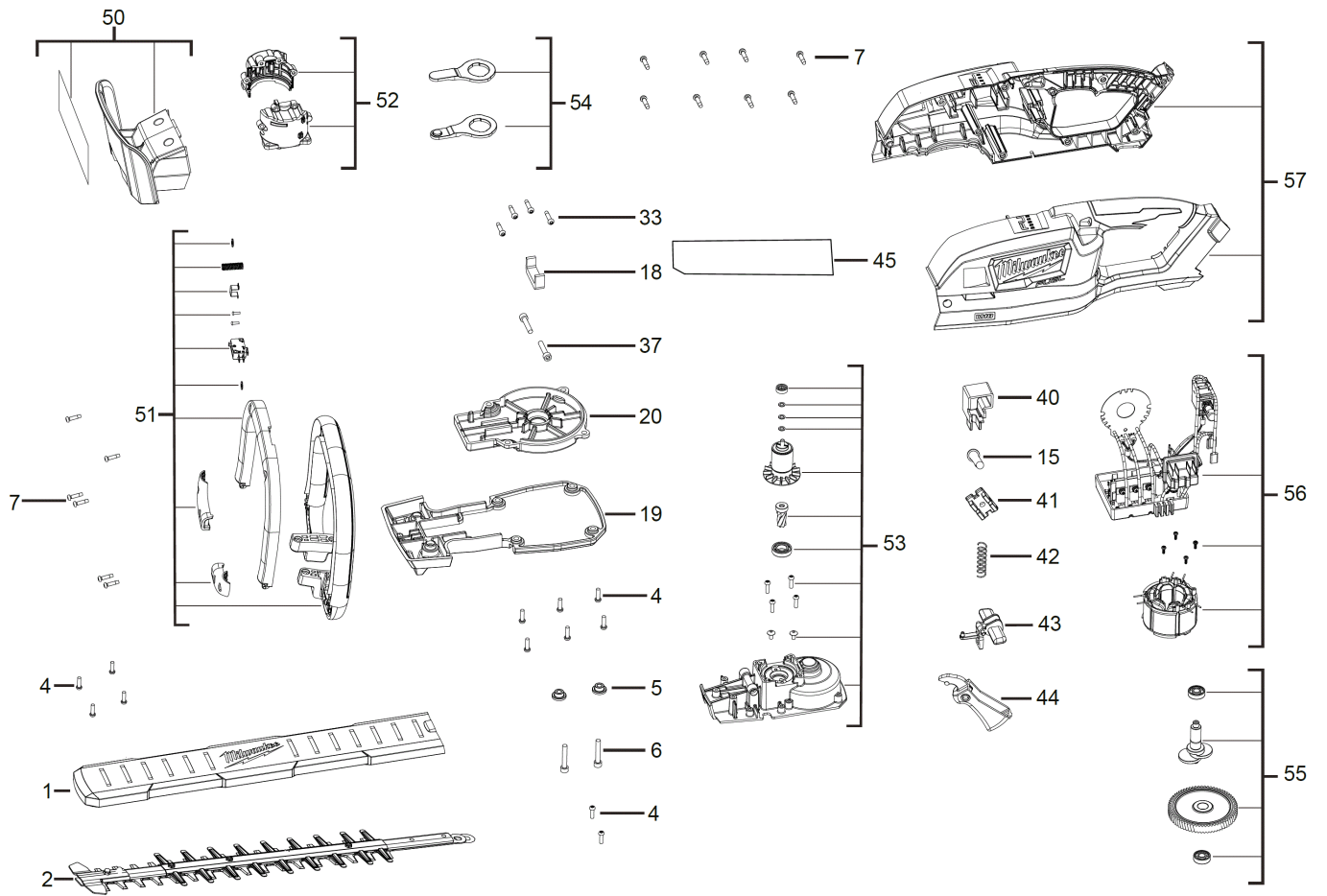

Position	Quantity	Description	Part number	EAN
0001 1	1	ABDECKUNG	4931496332	4058546534691
0002 2	1	DOPPELSCHERBLATT	4931496333	4058546534707
0004 3	16	SCHRAUBE	660414013	4002395823796
0005 4	2	DICHTBUECHSE	4931461351	4058546035235
0006 5	2	SCHRAUBE	4931461352	4058546035242
0007 6	14	SCHRAUBE	660024030	4002395826957
0015 7	1	SCHRAUBE	4931461353	4058546035259
0018 8	1	DICHTUNG	4931461354	4058546035266
0019 9	1	SCHUTZKAPPE	4931461355	4058546035273
0020 10	1	SCHUTZKAPPE	4931461356	4058546035280
0033 11	4	SCHRAUBE	4931461357	4058546035297
0037 12	2	SCHRAUBE	4931461358	4058546035303
0040 13	1	ABDECKPLATTE	4931461359	4058546035310
0041 14	1	ABDECKPLATTE	4931461360	4058546035327
0042 15	1	FEDER	4931435675	4002395864393
0043 16	1	DRUECKER	4931461361	4058546035334
0044 17	1	DRUECKER	4931461362	4058546035341
0045 18	1	LEISTUNGSSCHILD	4931496334	4058546534714
0050 19	1	SAEGESCHUTZ	4931496330	4058546534677
0051 20	1	SCHALTGRIFF	4931461365	4058546035372
0052 21	1	MOTORGEHAEUSE	4931480442	4058546424572
0053 22	1	ANKER F.ELEKTROMOTOR	4931461367	4058546035396
0054 23	1	KONTAKTEINSATZ	4931461368	4058546035402
0055 24	1	KURBELWELLE	4931461369	4058546035419
0056 25	1	SCHALTELEKTRONIK	4931461370	4058546035426
0057 26	1	GEHAEUSE	4931461371	4058546035433