

M12CHZ-602X AKKU-SAEBELSAEGE IN2

4933501117 - M12CHZ-602X - 4000505491

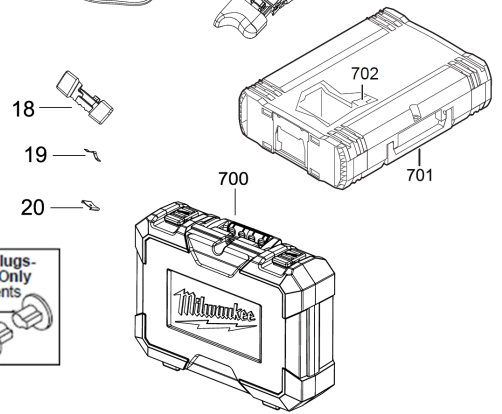
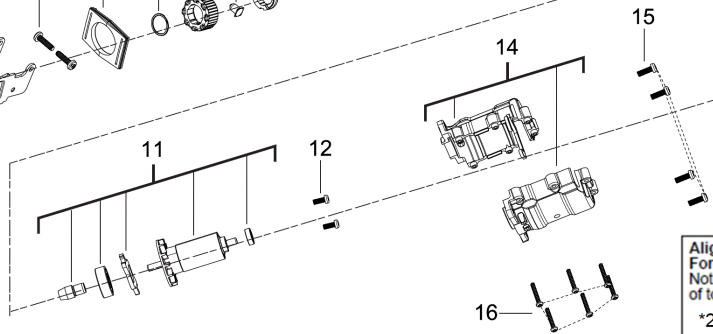
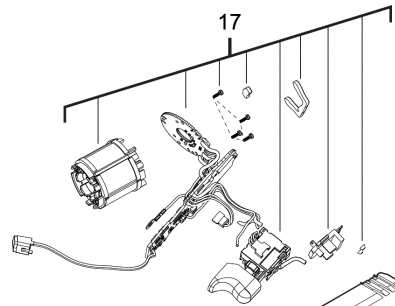
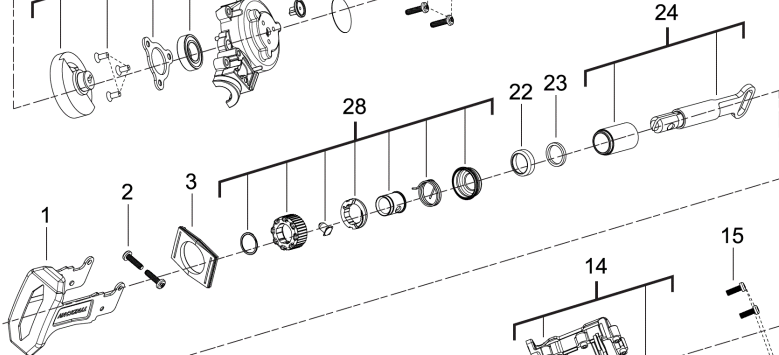
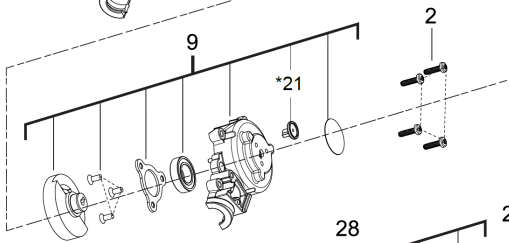
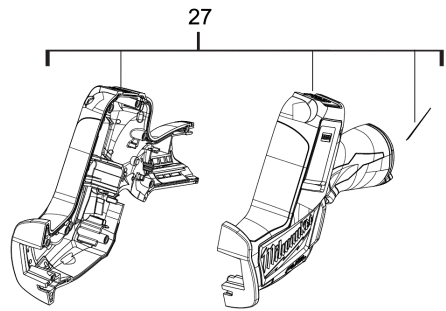
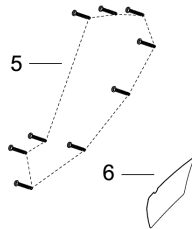
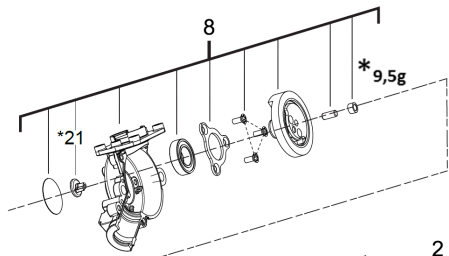

Alignment Plugs -
For Service Only
Not components
of tool.

*21

Position	Quantity	Description	Part number	EAN
0001 1	1	STEMPEL	4931511325	4058546651817
0002 2	6	SCHRAUBE	661113008	4002395830077
0003 3	1	GUMMIPLATTE	4931436220	4002395882328
0005 4	9	SCHRAUBE	661047001	4002395824496
0006 5	6	LEISTUNGSSCHILD	4931511308	4058546651640
0008 6	1	GEHAEUSE RECHTS	4931436217	4002395885091
0009 7	1	GEHAEUSE LINKS	4931436222	4002395882342
0011 8	1	ANKER F.ELEKTROMOTOR	4931436223	4002395882359
0012 9	2	SCHRAUBE	660165015	4002395849826
0014 10	1	ISOLATION	4931436224	4002395882366
0015 11	4	SCHRAUBE	660165011	4002395903702
0016 12	6	SCHRAUBE	4931511326	4058546651824
0017 13	1	SCHALTER M.ELEKTRO.	4931436226	4002395882380
0018 14	1	FUEHRUNG	4931436227	4002395882397
0019 15	1	FEDERBLECH	4931511327	4058546651831
0020 16	1	VERBINDUNGS-STUECK	631542001	4002395822591
0021 17	2	FUEHRUNG	520811001	4002395831159
0022 18	1	DECKEL	4931511328	4058546651848
0023 19	1	FILZ	902393001	4002395830732
0024 20	1	BUCHSE	4931436228	4002395883004
0025 21	1	FETT	49084175	45242175888
0027 22	1	HANDGRIFF-SET	4931511309	4058546651657
0028 23	1	WERKZEUGAUFNAHME	200783002	4002395802739
0700 24	1	TRANSPORTKOFFER	4931436218	4002395882304
0701 25	1	SYSTEMKOFFER MILWAUKEE GR.1	4932378986	4002395349401
0702 26	1	EINSATZ	4931447108	4002395253265