

AGV22-230E WINKELSCHLEIFER IN2

4933431850 - AGV22-230E - 4000509065

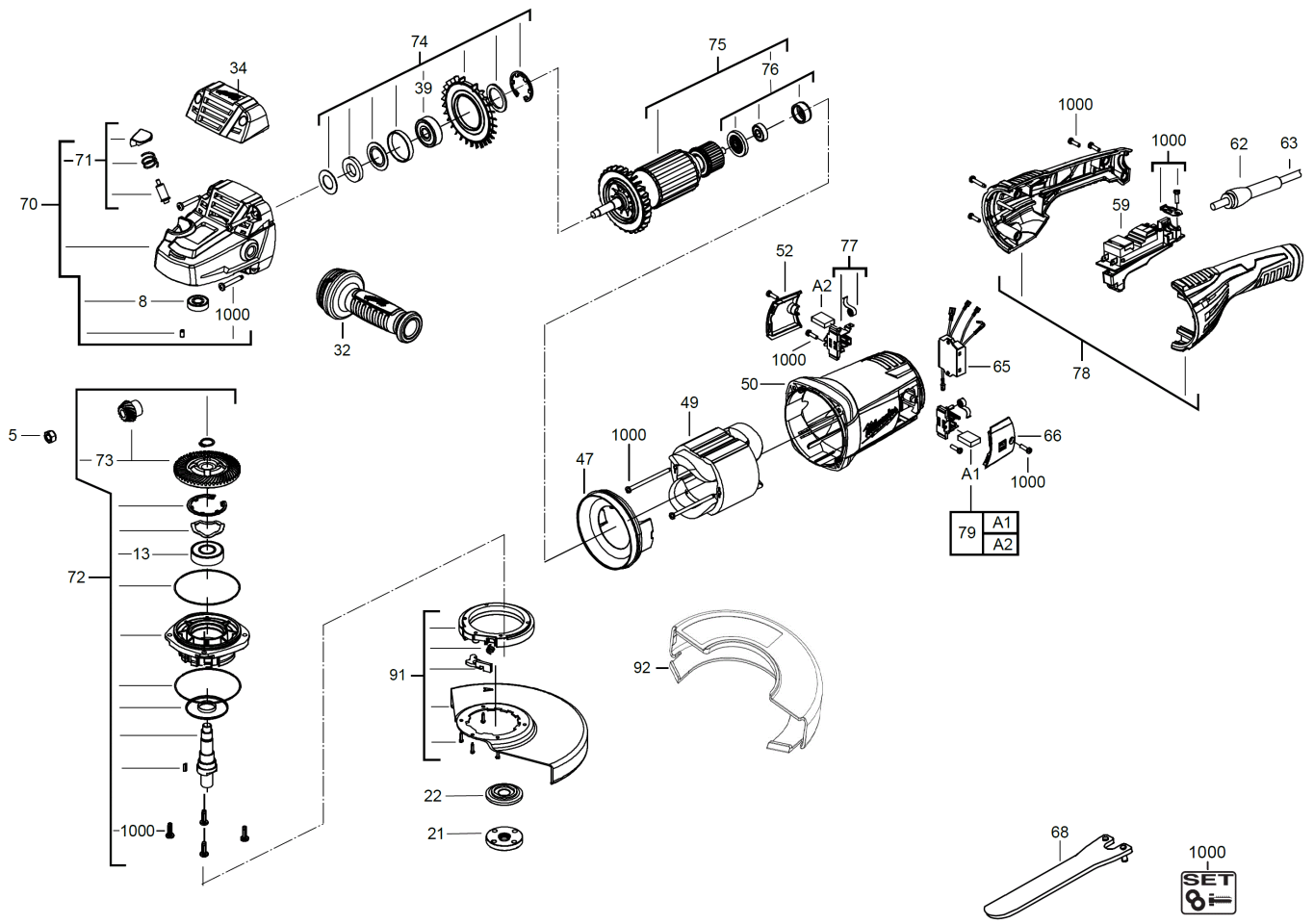



Position	Quantity	Description	Part number	EAN
0005 1	1	MUTTER	4931441045	4002395862603
0008 2	1	LAGER	4931441046	4002395862610
0013 3	1	LAGER	4931441047	4002395862627
0021 4	1	FLANSCHMUTTER	4931441048	4002395862634
0022 5	1	FLANSCH	4931441049	4002395862641
0032 6	1	HANDGRIFF KOMPL.	4931441051	4002395863358
0034 7	1	GETRIEBEKASTEN	4931441052	4002395863365
0039 8	1	LAGER	4931441053	4002395863372
0047 9	1	LUFTFUEHRUNGSRING	4931441054	4002395863389
0049 10	1	FELD F. ELEKTROMOTOR	4931441055	4002395863396
0050 11	1	MOTORGEHAEUSE	4931441057	4002395864010
0052 12	1	BUERSTENABDECKUNG	4931441058	4002395864027
0059 13	1	SCHALTER	4931441063	4002395864065
0062 14	1	KABELSCHUTZSCHLAUCH	4931441064	4002395864072
0063 15	1	ANSCHLUSSLEITUNG	4931441067	4002395861309
0065 16	1	ELEKTRONIK	4931441073	4002395861330
0066 17	1	BUERSTENABDECKUNG	4931441074	4002395861347
0068 18	1	SCHLUESSEL	4931441075	4002395861354
0070 19	1	Getriebekasten	4931441090	4002395863419
0071 20	1	VERRIEGEL.-ELEMENT	4931441091	4002395863426
0072 21	1	SPINDEL	4931441095	4002395863464
0073 22	1	Getriebe	4931441097	4002395863488
0074 23	1	LAGERSATZ	4931441098	4002395863495
0075 24	1	ANKER F.ELEKTROMOTOR	4931441099	4002395864102
0076 25	1	KUGELLAGER	4931441101	4002395864126
0077 26	1	BUERST.HALTER KOMPL	4931441102	4002395864133
0078 27	1	GEHAEUSE	4931441103	4002395864140
0079 28	1	KOHLEBUERSTEN-SET	4931441104	4002395864157
0091 29	1	SCHUTZHAUBEN-SET	4931507676	4058546601874
0092 30	1	FEDERKLEMME	4931507681	4058546601928
1000 31	1	SCHRAUBENSET	4931441114	4002395861408