

M18FSAG125X-0 Akku-Winkelschleifer XXX

4933478701 - M18FSAG125X-0 - 4000509120

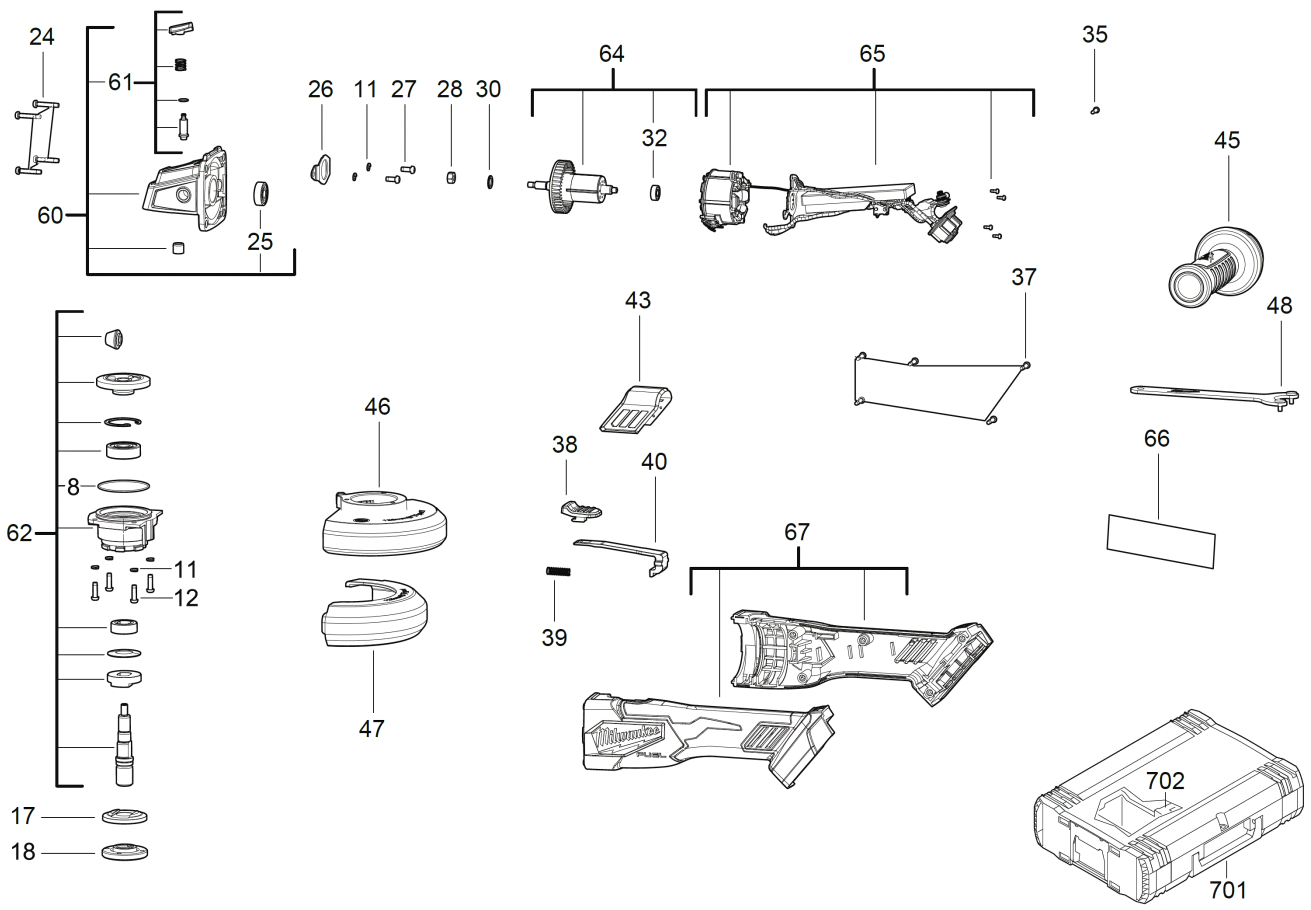



Position	Quantity	Description	Part number	EAN
0008 1	1	O-RING	4931479267	4058546385828
0011 2	6	SICHERUNGSRING	680866003	4002395823895
0012 3	4	SCHRAUBE	4931435150	4002395859948
0017 4	1	FLANSCH	4931479268	4058546385835
0018 5	1	FLANSCHMUTTER	4931441309	4002395887699
0024 6	4	SCHRAUBE	4931496932	4058546552466
0025 7	1	KUGELLAGER	4931448373	4002395250769
0026 8	1	HALTER	4931479269	4058546385842
0027 9	2	SCHRAUBE	660165015	4002395849826
0028 10	1	MUTTER	671686001	4002395824526
0030 11	1	SCHEIBE	4931479270	4058546385859
0032 12	1	KUGELLAGER	4931479271	4058546385866
0035 13	1	SCHRAUBE	4931436686	4002395258260
0037 14	5	SCHRAUBE	660031017	4002395825189
0038 15	1	SCHIEBER	4931479272	4058546385873
0039 16	1	FEDER	4931479273	4058546385880
0040 17	1	SCHIEBER	4931479274	4058546385897
0043 18	1	STAUBKAPPE	4931479275	4058546385903
0045 19	1	ZUSATZHANDGRIFF	4931435002	4002395855919
0046 20	1	SCHUTZ	4931479287	4058546386023
0047 21	1	TRENNSCHUTZHAUBE	4931479288	4058546386030
0048 22	1	SCHLUESSEL	4931479278	4058546385934
0060 23	1	GETRIEBEPLATTE	4931479279	4058546385941
0061 24	1	SPINDELARRETIERUNG	4931479280	4058546385958
0062 25	1	SPINDEL SATZ	4931479281	4058546385965
0064 26	1	ROTOR	4931479282	4058546385972
0065 27	1	ELEKTRONIK	4931479283	4058546385989
0066 28	1	LEISTUNGSSCHILD	4931507936	4058546625986
0067 29	1	GEHAEUSE	4931479285	4058546386009
0701 30	1	HD Box Groesse 1	4932453385	4002395146376
0702 31	1	EINSATZ	4931479286	4058546386016